

nobis
YOUR STOVE, OUR PASSION

EN - Installation, use and maintenance manual

UNICA 10 V/C



Dear Customer. Thank you for choosing a product from our range.
You are invited to read this manual carefully before using it, to take full advantage of all its features in full safety.
This manual contains information necessary for correct installation, start-up, use, cleaning and maintenance of the product.
Keep this manual in an appropriate place after reading it.
Improper installation, maintenance and use of the product relieve the manufacturer of any liability towards people or property.
All rights reserved. No part of this instructions manual can be reproduced or transmitted with any electronic or mechanical device, including photocopying, recording or any other saving system, for any purpose other than the exclusive personal use of the purchaser, without express written permission from the Manufacturer.

INDEX

1 Introduction	4	8 Menu browsing	17
1.1 Symbols	4	9 First start-up instructions	17
1.2 Intended use	4	9.1 Date and time settings	17
1.3 Improper use	4	9.2 Calibration of room temp. probe	17
1.4 Importance of the manual	4	9.3 User/auto management	18
1.5 General safety warnings	4	9.4 Room temperature settings	18
1.6 Legal warranty	5	9.5 Power settings	18
1.7 Exclusions from the warranty	5	9.6 Product switch-on	18
1.8 Spare parts	6	10 Operation	19
1.9 Identification plate	6	10.1 Saving mode	19
1.10 Disposal of the product	6	10.2 Comfort Clima	19
1.11 Hermetic product	6	10.3 "Powerful" function	20
2 Pellet recommended features	6	10.4 Ventilation management	21
3 Installation	7	11 Menu functions	21
3.1 Air intake	7	11.1 Programmable thermostat	21
3.2 Smoke channel and fittings	7	11.2 Auger loading function	22
3.3 Chimney flue	8	11.3 Pellet/Aspiration ratio	23
3.4 Chimney pot	8	11.4 Stove status	23
3.5 Hermetic product	8	11.5 Enabling external thermostat	24
3.6 Examples of correct installation	9	11.6 Language	24
3.7 Documents to be issued	10	11.7 Contrast	24
3.8 Product unpacking	10	11.8 FW version	25
3.9 Assembly of the canalization kit	10	11.9 Anticondensation	25
3.10 Assembly of the wooden panel	11	12 Canalization	25
3.11 Electrical connection	11	12.1 Single canalization	25
4 Maintenance	12	12.2 Programmed canalization	26
4.1 Smoke system maintenance	12	12.3 Display canalization status	26
4.2 Product maintenance	12	12.4 Double canalization	27
5 Technical data of the product	12	12.5 Programmed canalization	27
5.1 Product data sheet	12	12.6 Display canalization status	28
5.2 Technical features	12	13 Phase list	28
5.3 Dimensions	13	14 Function list	28
5.4 Safety distances	13	15 Signal list	29
6 Product configuration	13	16 Anomaly list	29
6.1 Remote control	13	17 Description of alarms	30
6.2 External thermostat	14	18 Cleaning the appliance	32
6.3 Pellet loading	14	18.1 Cleaning the fireplace	32
7 Description of the remote control	15	18.2 Cleaning the glass door	33
7.1 Receiver	15	18.3 Cleaning the ash pan	33
7.2 Keys	15	19 Wiring diagram	35
7.3 Display	15		
7.4 Flat battery	16		
7.5 Icon list	16		

1 INTRODUCTION

The product by Nobis was designed and manufactured in compliance with the reference standards for the manufacturing products (EN13240 wood stoves, EN14785 pellet appliances, EN13229 fireplaces/ inserts for wood, EN12815 wood stoves), with high quality materials. The products also comply with the essential requirements of the Directive 2014/35/EU (Low Voltage) and the Directive 2014/30/EU (Electromagnetic Compatibility).

The printing, translation and reproduction, even partial, of this manual is intended as binding by the manufacturer's authorisation and the content of working logic and explanatory figures is considered not to be disclosed.

Always consult the authorised technicians if in doubt and/or confused by operation of the the product.

The manufacturer reserves the right to make changes to specifications and technical and/or working features of the product at any time without prior warning.

1.1 SYMBOLS

The following manual contains symbols which highlight the importance of particular descriptions or concepts;



INFORMATION: Compliance with the specifications guarantees correct operation of the product.



ATTENTION: Symbol used to identify particularly important information



DANGER: The presence of this symbol indicates utmost attention is required, to guarantee user and product safety.

1.2 INTENDED USE

The product in this manual, is a fireplace for domestic heating, feed by automatic loading and exclusively with wood pellets.

The product was designed and manufactured to work in safety if the following conditions occur:

- installation by specialist staff according to the specific reference standards;
- use within the limits declared on the product data sheet and in this manual;
- compliance with technical procedures described in the manual;
- carrying out routine maintenance within the times and methods indicated in this manual;
- prompt execution of extraordinary maintenance if necessary (malfunctioning);
- activity and maintenance of safety devices (do not remove or bypass this devices).

1.3 IMPROPER USE

The product must be intended for the use for which it was expressly designed; for any other use, the manufacturer cannot be held in any way liable for damage caused to people, animals or property.

Improper use is intended as:

- use of the product as an incinerator;
- use of the product with fuel other than wood pellets with a diameter of 6 mm;
- use of the product with liquid fuel;
- use of the product with the fire door open and/or glass broken and/or ash pan removed and/or pellet tank open.

Any other use of the appliance other than that planned must be authorised in advance in writing by the manufacturer.

Furthermore, the manufacturer cannot be held in any way liable for errors in installation, adjustment or maintenance of the product.

1.4 IMPORTANCE OF THE MANUAL

The manual has the purpose of providing essential rules for correct installation, use and maintenance of the product.

PRESERVATION: Keep the manual in a place that is easy and quick to find;

DETERIORATION OR LOSS: Consult the official site to download the manual;

PRODUCT TRANSFER: In the event of sale between private individuals of the product, the owner is obliged to

deliver the product with the following manual.

1.5 GENERAL SAFETY WARNINGS

Non-compliance with the provisions of this manual can cause damage to people, animals and property.

- Installation, testing of the system, functionality testing and initial calibration of the product must only be carried out by qualified and authorised staff.
- The product must be connected to a single chimney flue that guarantees the draught declared by the manufacturer and which complies with the installation standards outlined in the assembly location of the product.
- The premises where the product is installed must be adequately ventilated (air intake).
- Do not touch the hot surfaces without adequate protective equipment, to avoid burns.
- When in operation, the external surfaces reach high temperatures.
- It is forbidden to make changes to the product unless expressly communicated in writing by the manufacturer.
- In the event of fire in the chimney flue, contact the Fire Brigade immediately.

- The product can be used by children over 8 years of age and people with reduced physical, sensor or mental capacity, or without experience or the necessary know-how, provided they are supervised, or have received instructions on the safe use of the appliance and have understood the dangers involved. Children must not play with the appliance.
- Cleaning and maintenance intended to be carried out by the user must not be carried out by children without supervision.
- Do not dry washing on the the product.
- Fuel and flammable materials must be kept a necessary distance from the product. Fire hazard.
- The product must be electrically connected to a system equipped with a sufficient ground system.
- In the event of a fault on the switch on system, do not force switch on using flammable materials and consult an authorised technician.
- For the no hermetic product, installation is forbidden in small rooms and bedrooms.
- Installation is forbidden in surroundings with explosive atmospheres.

1.6 LEGAL WARRANTY

The user, to benefit from the legal warranty, must strictly comply with the provisions indicated in this manual. In particular:

- always work within the use limitations of the product;
- always carry out routine maintenance;
- authorise people to use the machine with proven capacity, attitudes and who are adequately trained for the purpose;
- use original spare parts and specifically for the appliance model.

It is also necessary to provide a:

- fiscal receipt with the purchase date;
- a certificate of compliance issued for installation by authorised staff.

Non-compliance with the provisions contained in this manual will imply immediate expiry of the warranty on the product and on any spare parts assembled later.

1.7 EXCLUSIONS FROM THE WARRANTY

The warranty excludes all malfunctions and/or damage to the appliance resulting from the following causes:

- damage caused by transport and/or movement;

- all parts resulting as being faulty due to negligence or careless use, wrong maintenance, non-conforming installation with that specified by the manufacturer (refer to the installation and use manual supplied with the appliance);
- further damage caused by wrong intervention by the user in an attempt to solve the initial fault;
- aggravated damage caused by further use of the appliance by the user once the defect was noted;
- in the presence of a boiler, any corrosion, scale or breakages caused by stray current, condensate, abrasion or acidity in the water, scale removal treatments carried out improperly, no water, sludge or limescale deposits;
- inefficiency of the chimneys, chimney flues or parts of the system on which the appliance depends;
- damage caused by tampering with the appliance, atmospheric agents, natural disasters, vandalism, electrical discharge, fire, faulty electrical and/or plumbing system.

The following are also excluded from the warranty:

- parts subject to normal wear such as gaskets, glass, coverings and grates in cast iron, painted, chrome-plated or gold-plated parts, handles and electrical cables, lights, switch on resistor, indicator lights, knobs, all parts that can be removed from the fireplace (e.g. refractory, brazier);
- colour variations of painted and ceramic parts, as well as the ceramic cracks since they are natural features of the material and use of the product;
- masonry works;
- parts of the system (if present) not supplied by the manufacturer;

Any technical intervention on the product to eliminate the aforementioned defects or resulting damage should therefore be agreed with the Technical Support Centre, which reserves the right to access or refuse the relevant job and in any case they will not be carried out under warranty, but rather Technical Support will provide the possible conditions to specifically agree upon and according to rates in force for the works to carry out.

The user will also be responsible for the expenses which will be necessary to resolve any wrong technical intervention, tampering or however damaging factors for the appliance not attributable to the original defects.

Notwithstanding the restrictions imposed by legislation and regulations, every warranty to contain atmospheric and acoustic pollution is also excluded.

1.8 SPARE PARTS

Only use original spare parts.

Do not wait for the components to wear from use before replacing them.

This measure promotes prevention of accidents caused by people, animals or property in the event of product malfunctioning caused by faults.

You are advised to contact authorised staff to replace spare parts, worn parts and for extraordinary maintenance of the the product.

1.9 IDENTIFICATION PLATE

The plate placed on the back of the product outlines all the characteristic data of the appliance, including the manufacturer's data, the serial number and the CE marking.

1.10 PRODUCT DISPOSAL

Demolition and disposal of the product is the exclusive responsibility of the owner, who should do so in compliance with legislation in force in his country on safety matters, with respect of and safeguarding the environment.

At the end of its useful life, the product must not be disposed of as urban waste.

It can be delivered to specific differentiated waste collection centres made available by municipal administrations, or dealers who provide this service.

Disposal of the product as differentiated waste means possible negative consequences for the environment and health are avoided, deriving from inadequate disposal. Furthermore, it allows recovery of materials composing the product to obtain important savings in energy and resources.

1.11 HERMETIC PRODUCT

The products manufactured with a perfectly hermetic

structure do not consume oxygen in the environment, since they take all the air from outside the home (if correctly installed) and can therefore be positioned inside all homes with a high level of insulation, such as "passive houses" or "with high energy efficiency". Thanks to this technology, there is no risk of smoke emissions in the environment and no ventilation grates are necessary.

As a result, no cold air flows are created in the environment making it less comfortable and reducing the overall efficiency of the system. Hermetic products can also be installed in the presence of forced ventilation or in premises which can go into negative pressure compared to outside.

2 PELLETS RECOMMENDED FEATURES

Wood pellets are fuel made of pressed sawdust, often recovered from carpentry processing waste. The material used cannot contain any foreign substance such as glue, varnish or synthetic substances.

Sawdust, after drying and cleaning of impurities, it is pressed using a matrix: due to the high pressure, the sawdust heats activating the natural binders in the wood; by doing so, the pellet maintains its shape even without adding artificial substances. The density of wood pellets varies based on the type of wood and can exceed 1.5 - 2 times that of natural wood.

The cylinders have a diameter of 6mm and a variable length of 10 to 40mm.

Their density is equal to approx. 650 kg/m³. Due to the low water content (< 10%), they have a high energy content.

The main quality certifications for pellets on the European market today guarantee the fuel is within class A1 in according to ISO 17225-2:2014 (formerly EN 14961). Examples of these certifications are for example ENPlus, DINplus, Ö-Norm M7135, and guarantee they comply in particular with the following characteristics:

- heating power: 4.6 ÷ 5.3 kWh/kg;
- water content: ≤ 10% of weight;
- percentage of ash: max 1.2% of weight (A1 under 0.7%);
- diameter: 6±1/8±1 mm;
- length: 3÷40 mm;
- content: 100% untreated wood without any additional binder substances (percentage of bark max 5%);
- packaging: in sacks made from eco-compatible or bio-degradable.



The manufacturer recommends, for its products, use of class A1 certified fuel according to the standard En ISO 17225-2:2014, or certified DIN PLUS (more restrictive than class A1) or O-NORM M7135.



Pellets must be kept in a dry environment which is not excessively cold. You are also advised to keep some bags of pellets where the product is installed and operating, to dry them of any humidity present. Non-compliance with this aspect reduces the thermal power of the fuel and means greater maintenance must be done on the product.

3 INSTALLATION

 All local and national legislation and European standards must be met when installing and using the the product.

The assembly position must be chosen based on the environment, the discharge and the chimney flue. Check, with your local authority, if there are more restrictive provisions regarding the oxidising air intake, the smoke discharge system including the chimney flue and chimney pot.

The manufacturer cannot be held in any way liable in the event of installation non-compliant with legislation in force, of incorrect premises air exchange or electrical connection non-conforming with standards and/or inappropriate use of the appliance.

Installation must be carried out by a qualified technician, who will issue the purchaser with a Declaration of Conformity for the system and will assume complete responsibility for final installation and resulting good operation of the product.

In particular, he should ascertain:

- there is an adequate oxidising air intake and good smoke discharge compliant with the type of product installed;
- other stoves or devices installed do not cause negative pressure in the room where the product is installed (only for hermetic appliances, a maximum of 15 Pa depression in the surroundings is permitted);
- when the product is on, there is no smoke back draught in the surroundings;
- smoke evacuation is implement in total safety (dimensioning, smoke seal, distances from flammable materials..).

Once the position is decided where to install the product, you need to pay attention:

- if the floor is made of combustible material, you should use protection in suitable material (steel, glass...) which also protects the front part from any falling burning fuel during cleaning operations;
- that the floor guarantees adequate load capacity if the existing building does not meet this requirement, you should take appropriate measures (for example a load distribution plate).

3.1 AIR INTAKE

The installation premises of non-hermetic appliances must be sufficiently ventilated with specific openings, with particular attention on the position (they must NEVER be blocked), which consent air reintegration in the environment.

The air must be taken directly from outside (not from other rooms, garage, etc.) and must have a net useful section equal or higher than 80 cm² pellet burning stoves and thermostoves (EN 14785) and 100 cm² for boilers (EN 303-5).

The air intake is not necessary for installation of the hermetic appliances that take air directly from outside. Check and comply with the ventilation requirements for simultaneous operations with other combustion devices and in the presence of forced ventilation systems or hoods (refer to section 6.4 of UNI 10683).

3.2 SMOKE CHANNEL AND FITTINGS

The term smoke channel indicates the piping connecting the appliance to combustion with the chimney flue.

For heat generating appliances with an electric fan to expel the smoke, the following installation instructions must be followed, provided by the manufacturer concerning the maximum length and number of curves the smoke channels can have.

If no indications are given for maximum values or deriving from preliminary calculations according to UNI EN 13384-1, the following provisions must be applied:

- comply with the product standard EN1856-2;
- the horizontal sections must have a minimum slope of 3% upwards;
- the length of the horizontal section must be minimal and its projection on plan must not exceed 4 metres;
- the number of changes of direction including introduction in the chimney flue and excluding that by effect of using a "T" element in the appliances with rear smoke output, must not exceed 3;
- the changes of direction must not have an angle over 90° (45° curve recommended);
- the section must have a constant diameter equal to the output of the fireplace up to the fitting in the chimney flue;
- it is forbidden to use flexible metal and fibre cement piping, furthermore the piping must guarantee pressurised sealing;
- the smoke channels must not cross premises in which installation is forbidden of combustion appliances;
- Use watertight piping with silicone gaskets.

In any case, the smoke channels must be sealed by combustion and condensate products, as well as insulated if passing inside the installation premises.

Assembly is not permitted of draught manual adjustment devices on forced draught appliances.

 You need to install a first vertical smoke channel section of at least 1 metre to guarantee correct smoke ejection.

3.3 CHIMNEY FLUE

When installing the chimney flue, the following provisions must be applied.

- comply with the product standard EN 1856-1;
- it must be installed using materials suitable to guarantee resistance to normal mechanical and chemical stress, and have a correct insulation, to avoid the formation of condensate, therefore it must be hermetically insulated;
- have a mainly vertical state and not be choked along its length;
- be correctly spaced using air cavities and insulated from flammable materials,
- the changes in direction must be at most 2 and with an angle not exceeding 45°;
- the chimney flue inside the home must however be insulated and can be inserted in a cavity provided it complies with the relevant piping standards;
- the smoke channel should be connected to the chimney flue using a "T" joint with an inspectable collection chamber for collection of fuel residue and, in particular, for condensate collection.

! It is not possible to connect the appliance to a chimney flue shared with other combustion appliances or in the presence of hood exhausts.

! It is forbidden to use direct wall discharge or towards closed spaces or any other form of discharge not planned by legislation in force in the country of installation (In Italy, only roof discharge is permitted)

! You are advised to check the safe distances which must be complied with in the presence of combustible materials and the type of insulating material to use (data available directly on the chimney flue plate)

3.4 CHIMNEY STACK

The standard UNI 10683 states the stack must meet the following features:

- the smoke outlet section must be at least double the inner section of the chimney;
- shaped to prevent water or snow penetration;
- be built in such a way that wind cannot affect the smoke outlet (wind-proof cap);
- the opening measurement, which is measured between the lower coverage protective layer and the lower point of the smoke outlet section into the atmosphere, must be outside the back draught area;
- Be built far from antennas or satellite dishes and must never be used as a support.

3.5 HERMETIC PRODUCT

In the event of installation of a hermetic product, you can execute one of the following types of connection with the piping:

- smoke discharge (1) and recovery of oxidising air directly from outside (2)

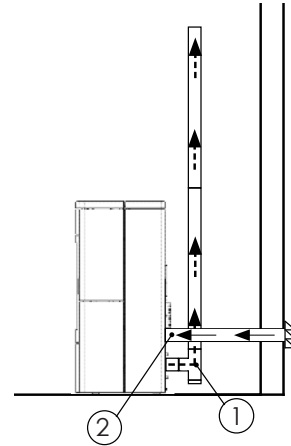

- smoke discharge (1) and oxidising air channelling (2) taking advantage of its coaxial discharge to expel the smoke and pick the air; therefore, installation is not necessary of a grate to recirculate the air inside the premises where the the product.

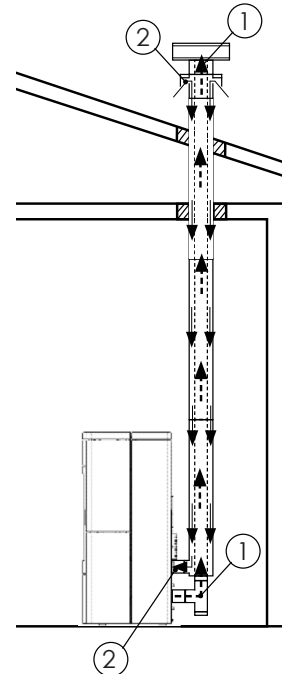

! For coaxial installation or air sampling directly from the outside, it is recommended not to exceed 2.5/3 linear meters in order to ensure correct oxygen supply to combustion.

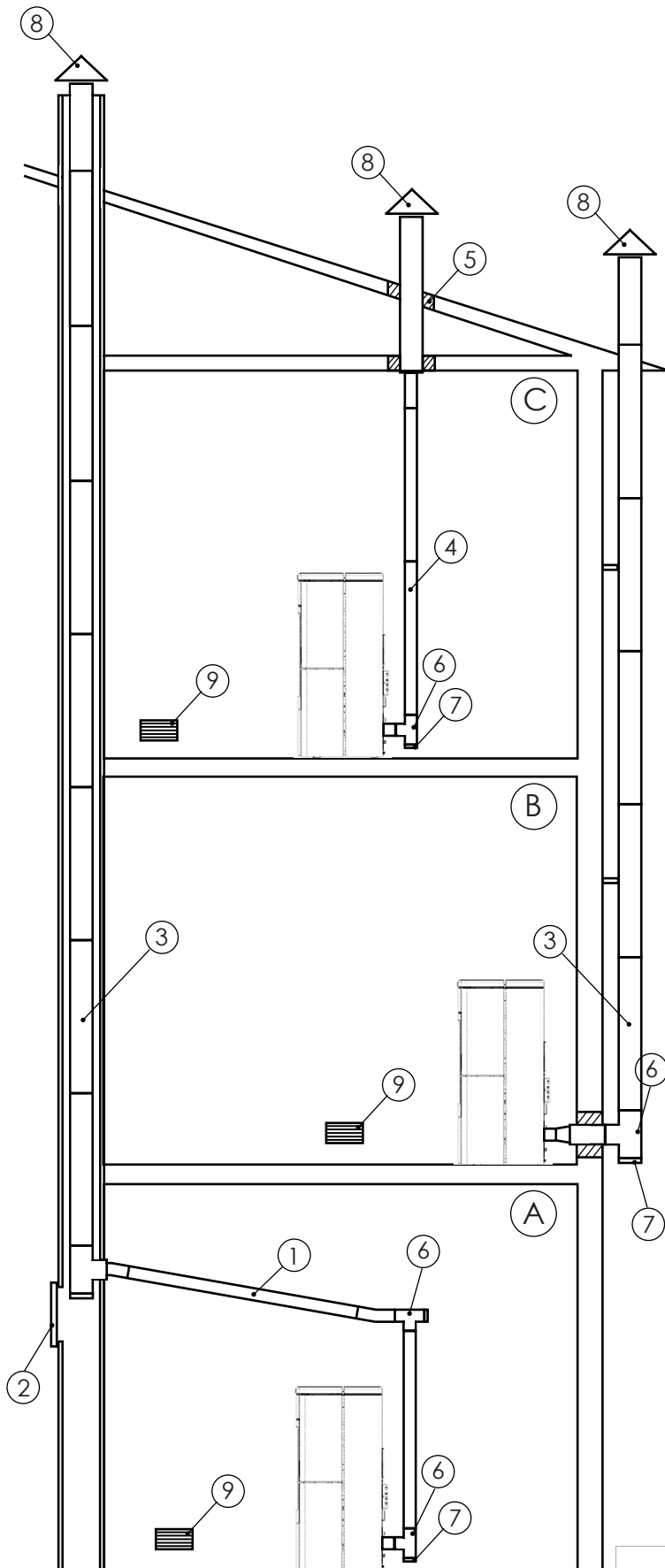

3.6 EXAMPLES OF CORRECT INSTALLATION

installation of the product (A) necessary for the horizontal section for connection to an existing chimney flue. Based on a slope of 3-5%, to reduce ash deposit in the horizontal pipe section which must not be over 3m (1). The existing chimney flue must be inspectionable (2).

Installation of the product (B) requires an insulated chimney flue (3) with an internal diameter of no less than 100mm, since all the smoke piping was assembled outside the home.

Installation of the product (C) requires a single wall chimney flue (4) for the section inside the home. Relating to the part placed in the attic, you are advised to install a chimney flue Ø120mm, with perforation for passage of the piping, extended to:

- minimum 100mm around the pipe if in contact with inflammable parts such as cement, bricks, etc.;
- minimum 300mm around the pipe (or as described in the plate data) if in contact with flammable parts such as wood etc.

In both cases, insert adequate insulation (5) between the chimney flue and the attic.

You are advised to check and comply with the plate data of the chimney flue, in particular the safe distances from combustible materials.

The previous rules also apply for holes made on walls.

On the lower part of the chimney flue, for all 3 installations, a "T" fitting (6) was assembled with an inspection plug (7), as well as on the inlet of the chimney flue.

The upper part of the chimney flue, for all 3 installations, has a wind-proof chimney pot (8) assembled.

In the home, for all 3 installations, a grate is planned to guarantee correct oxygenation of the premises where the product is positioned.

Grate not necessary if appliance is hermetically sealed.

⚠ It is not recommended to install a 90° curve as an initial section which would quickly cause ash to block smoke passage, causing draught problems in the appliance.

⚠ In the event of particular atmospheric conditions and/or hostile draught conditions, the product can overcome these situations provided due installation measures are in place, for example a wind-proof chimney pot.

3.7 DOCUMENTATION TO ISSUE

When installation is concluded, the installation technician must deliver to the user:

- the use and maintenance booklet of the appliance supplied by the manufacturer;
- the technical documentation of the accessories used and subject to maintenance;
- the documentation relevant to the evacuation system of combustion products;
- The system booklet (where planned);
- the documentation certifying installation;

The useful documentation for installation liability must include:

- a detailed description (also including photographs) of the presence of other heat generators;
- Declaration of Conformity of the system to standard (M.D. 37/08);
- general description, or diagram or photographic documentation of the changes made to the system, if intervention was necessary during installation;
- Use of certified material with the CE mark (305/2011);
- possible instructions relating to the warranty;
- the date and signature of the installation technician;



NOBIS SRL cannot be held in any way liable in the event of non-compliance with the installation and start-up standards of its products.

3.8 UNPACKING THE PRODUCT

Packaging is composed of boxes in recyclable cardboard according to the RESY standards and wooden pallets. All packaging materials can be re-used for similar use or, if necessary, disposed of as urban waste, in compliance with legislation in force.

Remove the strap binding the pallet to the packaging and lift the cardboard; remove the plastic bag around the product, ensuring it is intact.

The body must always be moved in a vertical position using trolleys.

Pay particular attention so that the door and its glass are protected against mechanical impact which would compromise their integrity.

If possible, unpack the product near the area where it will be installed.

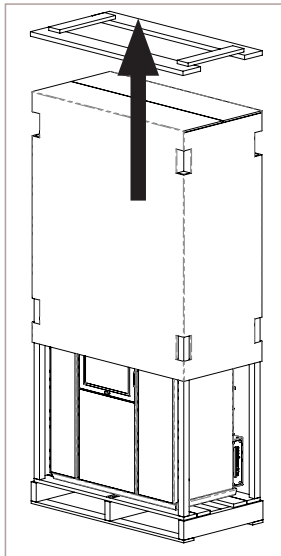

To remove the appliance from the pallet, you can remove the two screws placed under the pallet (13 hex key) to release the appliance from the wooden base.

Position the product and proceed with its connection to the chimney flue. Find, using the 4 adjustment feet, the right level so that smoke discharge and the pipe are properly correctly.

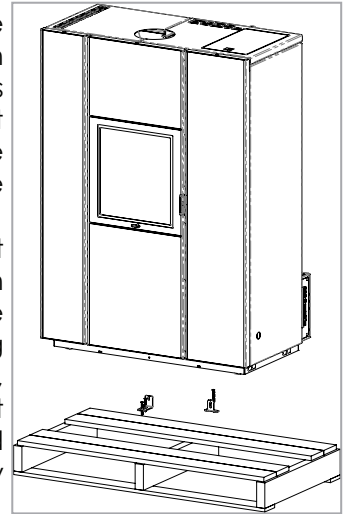

Unlock the control mechanism of the fume safety hatch (located on the rear right side of the pellet tank cover) by loosening the locking screw of the support to release it. Pay attention to the lever, for it will rise due to the fact that the stove is not powered. Tighten the screw back in place after removing the support.

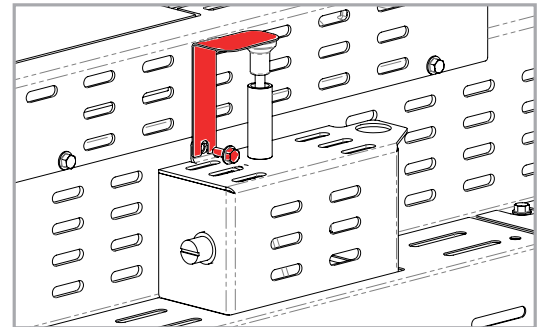

3.9 ASSEMBLY OF THE CANALIZATION KIT

Remove the screws securing the upper left cover of the diffuser.



Installing the canalization kit without removing the pre-drilled sheet will result in NO heat being emitted from the canalization kit.

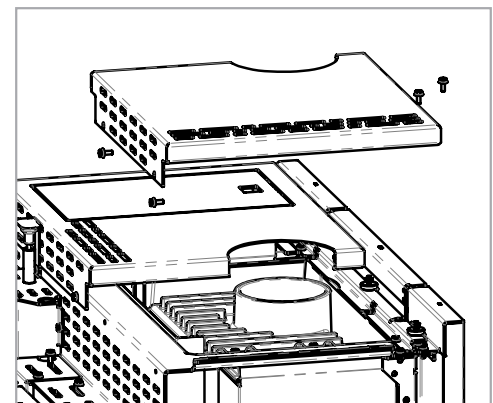

Remove the wooden cover (which is attached on the underside by means of magnets). Then unhook the side panel by unscrewing the two upper fixing screws. Remove it by lifting it from the lower screws (bayonet joint). Loosen the two screws holding the rear panel at the top (highlighted by the circles) and remove it.

Detach the pre-drilled sheet metal on the left or the one on the back, depending on the desired orientation of the canalization.

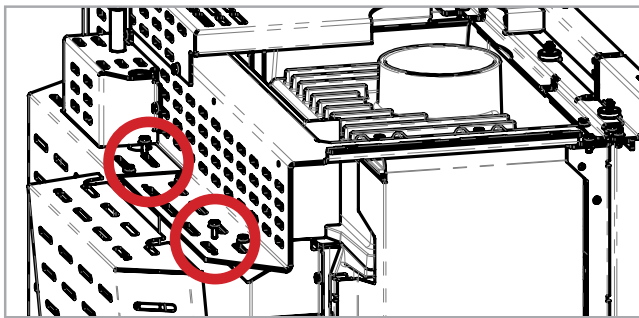
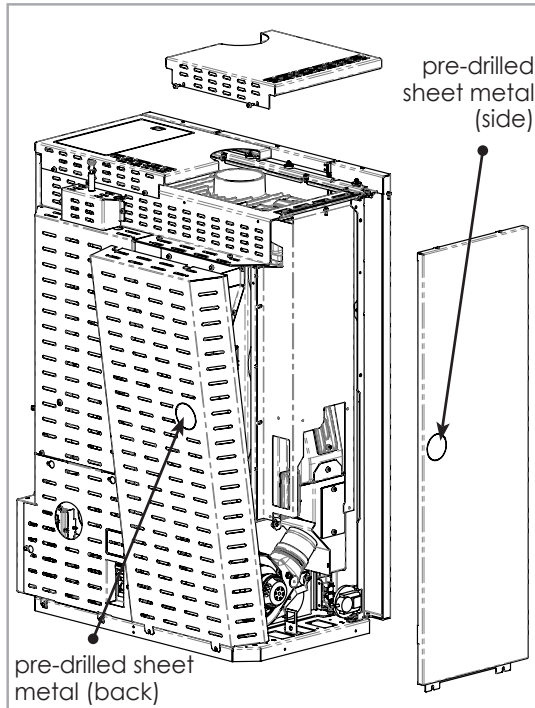

Fasten the canalization kit using the 5 screws (highlighted) already present in the stove

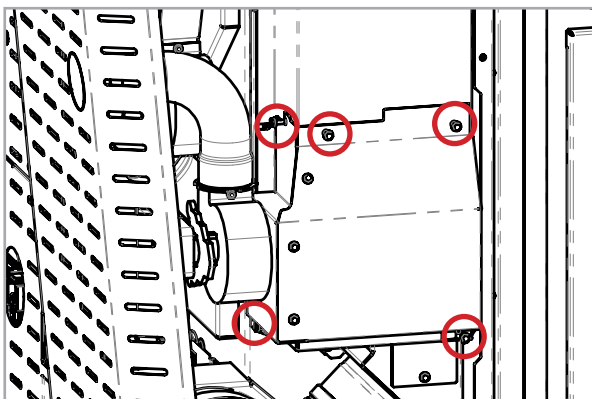

Connect the fan using the CANAL appendix, already present in the original wiring of the product. Live and Neutral can be inverted, unlike Earth connection (yellow/green colored cable) which must be connected to the earth of the fan.

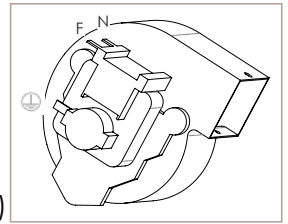

Reassemble the product and, once powered, go to USER SETTINGS> SETTINGS> CANALIZATION and choose the setting SINGLE to take advantage of canalization (see menu dedicated to canalization in following pages of the manual).

3.10 ASSEMBLY OF THE WOODEN PANEL

Le cornici in legno sono dotate di magneti e si collegano in modo semplice alla base della stufa: rispettare gli incastri a 45° per la parte frontale (vediempio in figura).

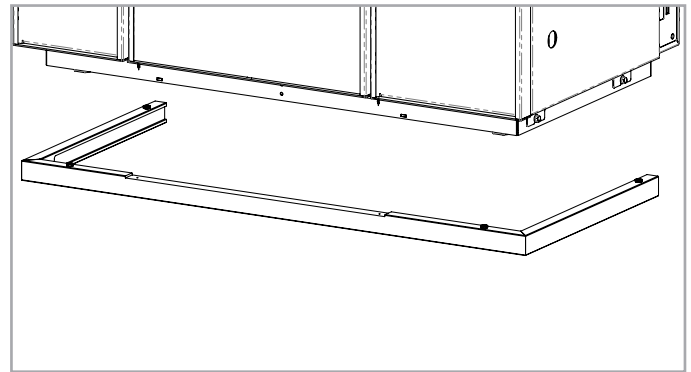

3.11 ELECTRICAL CONNECTION

The product power supply cable must only be connected after concluding installation and assembly of the product, it must not be in contact with hot parts and must remain accessible after installation.

To carry out the electrical connection, proceed as described below:

- connect the power supply cable on the back of the appliance;
- connect the cable plug to the current socket on the wall.

i You can connect an outer thermostat with timer to the appliance for its regulation or to switch on and off. For connection and management of the "external thermostat" function, refer to the specific chapter in the following pages of this manual.

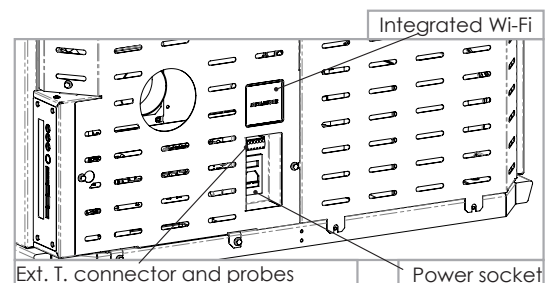

! It is compulsory for the system to be grounded and have a differential switch in compliance with legislation in force. Furthermore, ensure the socket is compatible with the type of plug on the power cable used.

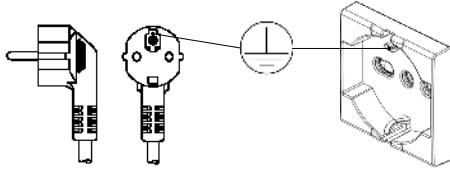

4 MAINTENANCE

The maintenance operations, excluding routine cleaning (explained in the relevant paragraph), must be carried out by authorised, technical staff. Remember, before carrying out any maintenance operation, implement the following precautions:

- all parts of the product must be "cold";
- ensure there is no form whatsoever of combustion (for example ash still hot);
- use of safety devices as per the directive;
- remove the plug from the electrical socket;
- having terminated maintenance, reset the product paying attention to re-activate all the safety devices.

4.1 SMOKE SYSTEM MAINTENANCE

The chimney flue must always be cleaned, since deposits of soot or fuel residue reduce the section blocking its draught, compromising good operation of the product and, if in large quantities, can catch fire. It is compulsory to have a qualified chimney sweep clean and check the chimney flue and the stack at least once a year or after prolonged stoppage due to non-use of the appliance. At the end of the control/maintenance, ask for a report to be issued stating the system is safe.

Lack of cleaning prejudices safety of the system.

4.2 PRODUCT MAINTENANCE

Carry out at least once a year or on each "Service Hours" signalling (signal that appears on screen when the working hours have been exceeded, over which excellent product operation is not guaranteed). In this phase, the authorised technician should:

- completely and accurately clean the smoke pipes;
- check the sealing status of all the gaskets;
- remove broken pellet residue inside the pellet tank;
- re-assemble all parts of the appliance;
- check correct operation and good quality combustion.

5 TECHNICAL DATA OF THE PRODUCT

This chapter issues to the end user all the information relating to the technical data of the product, the dimensions, the installation measurements, the minimum distance to comply with from walls and furniture, sofas, etc.

5.1 PRODUCT DATA SHEET

PRODUCT DATA SHEET	
EU 2015/1186	
Brand	Nobis
Model	Unica 10
Energy efficiency class	A+
Direct thermal power (Kw)	9.3
Indirect thermal power (Kw)	-
Energy efficiency index	127,6
Useful efficiency (Nominal power %)	90,0
Useful efficiency (Reduced power %)	91,0
Comply with the warnings and instructions for installation and periodic maintenance of the instructions manual.	

5.2 TECHNICAL FEATURES

Model	UNICA 10 V/C	
	Ridotto	Nominale
Weight of appliance (kg)	250	
Ø air inlet (mm)	80	
Ø smoke outlet pipe (mm)	130	
Vol. max. heating* (m³)	228	
Power (kW)	4,6	10,3
Yield (kW)	4,2	9,3
Yield (%)	91,0	90,0
CO 13% O ₂ (mg/m³)	94,0	64,0
Tank capacity (kg)	18,0	
Pellet hourly consumption (kg/h)	0,96	2,17
Autonomy (h)	18,8	8,3
Absorbed electrical power (W)	400	
Electrical power supply (V-Hz)	230-50	
Discharge gas flow (g/s)	4,1	5,7
Minimum draught (Pa)	12	12
Smoke temperature (°C)	165	258

*This value can vary based on the type of energy class of the home and the type of pellet used.

The data outlined are approximate and non-binding and can vary based on the type of pellet used. The manufacturer reserves the right to make changes for the purpose of improving product performance.

5.3 DIMENSIONS

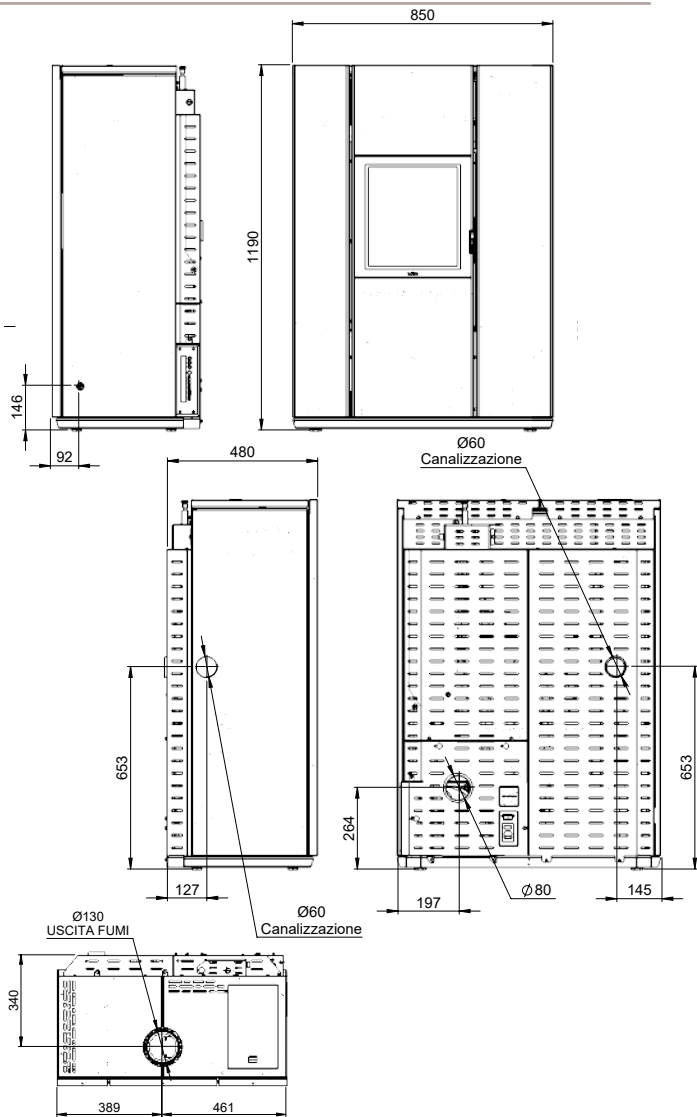

5.4 SAFETY DISTANCES

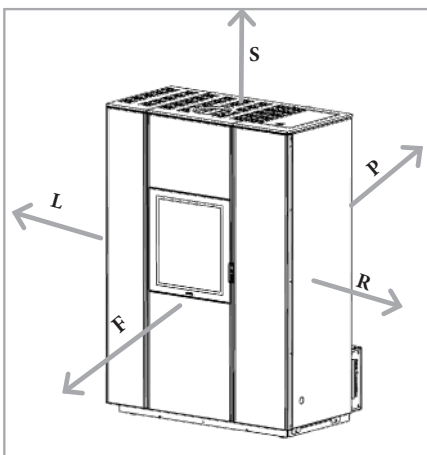

Minimum distance from flammable materials		
R	Right-hand side	400 mm
L	Left-hand side	400 mm
P	Rear	100 mm
F	Front	1000 mm

6 PRODUCT CONFIGURATION

Once all the installation, covering assembly (where present as a kit) and electrical connection are in place, with utmost attention, access the rear part of the product to power it.

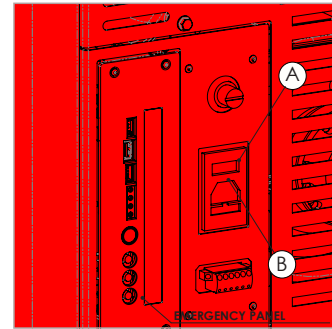

The "I/O" (A) switch in the figure above must be positioned on "I". In the event of a power failure, check the condition of the fuse placed under the switch (B) (4A fuse EU configuration). During periods of non-use, you are advised to disconnect the cable powering the appliance, and also the batteries from the handheld device.

6.1 REMOTE CONTROL

Remove the protective cover of the batteries on the rear of the remote control, as in the figure (A), and insert 3 batteries (type AAA Alkaline 1.5V) in the handheld device compartment, paying attention to polarity. Close the protective cover of the batteries as in the figure (B).



The batteries, once exhausted, must be disposed of in the dedicated collection centers.

To protect the battery from adverse conditions or misuse, remember to:

- keep the command away from heat sources, risk of explosion;
- remove the batteries in case of prolonged not use of command, risk of oxidation and liquid leakage;

Nobis srl declares that the type of "Handheld" radio device complies with Directive 2014/53 / EU.

The full text of the EU declaration of conformity is available at the following Internet address:

<https://www.nobisfire.it/wp-content/uploads/2019/04/DoC-Palmare-Radio-Nobis-1.pdf>

The handheld device, after a first short screen with the manufacturer's logo, lists a series of languages available on the menu.



Select the language, using the keys that you want to use as the display standard. Press the key to confirm and go to the next screen.

To work correctly, the handheld device requires interfacing with the electronic board inside the product. For this reason, the display shows a first installation message.

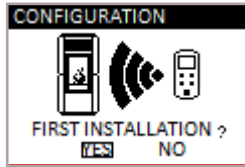

If first use of the handheld device, choose **YES** with the selection keys . Press the key to confirm and go to the next screen.

Follow the guide instructions to link via remote the appliance to the display, as outlined in the figure below.

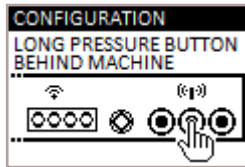

Keep the remote communication key of the electronic board pressed for a few seconds, placed on the rear of the product, to start the unit search procedure.

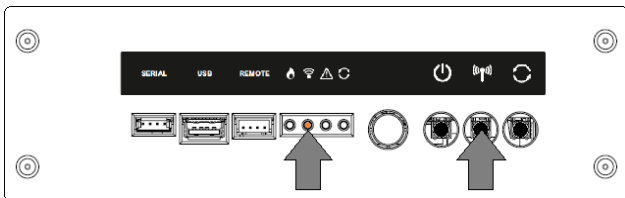

The yellow, flashing led, under the icon indicates the electronic board is waiting to receive the remote control signal.

Pressing the confirm key on the handheld device, the components can communicate with one another.

A tick sign on the display, accompanied by an acoustic signal, indicates the remote connection operation has successfully concluded.



If the batteries are replaced, you don't necessarily have to follow the initialisation procedure of the handheld device. In this case, when the display shows the message "FIRST INSTALLATION?", select **NO** and press the confirm key.

6.2 EXTERNAL THERMOSTAT

If you want to manage the appliance from a different room (in that specific room, the remote handheld device cannot communicate), you can connect an external thermostat to the product, to allow modulation of combustion or, by activating a particular function, allow switch on or off of the product. As in the figure below, connect the terminals of the thermostat to the terminal board on the back of the product (near the emergency panel).

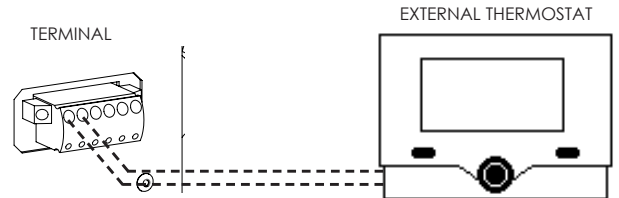

Following electrical connection, to allow the control unit to recognise the presence of the t.ext, the recognition function must be enabled from the SETTINGS menu (see the "ENABLE EXTERNAL THERMOSTAT" paragraph)

By enabling the function that allows external thermostat enabling, on the handheld device reading and management of the ambient temperature are inhibited. The handheld device displays TON if required, TOFF if the temperature set on T.ext is reached.

6.3 PELLET LOADING

Fuel is loaded by inserting pellets from the upper part of the product, opening the door. Ensure the content of the bag of pellets does not fall around the edges of the tank, paying particular attention to centring, during the loading phase. Also avoid the pellet packaging coming in contact with hot surfaces.

Ensure you correctly close the cover of the tank again after loading the pellets. Closure is controlled by an electronic contact (for the models where planned). In the event of non-closure, a sign warns the user to pay attention to tightening, before passing to alarm mode, in the event the warning is ignored.

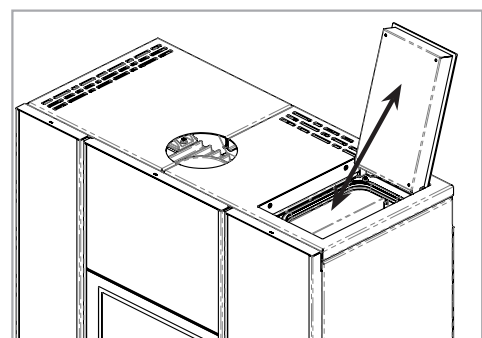

7 DESCRIPTION OF THE REMOTE CONTROL

Before switching on the appliance, you are advised to read the following chapter carefully relating to use of the receiver and the handheld device, as well as their related functions.

INFORMATIVE NOTE:

- frequency bands and transmitted power used by the equipment as reported in technical documentation: 868.3MHz - 869.85MHz
- frequency bands and respective power limits transmitted applicable to the device (frequencies and standardized powers): 6dBm ERP.

7.1 RECEIVER

The appliance is equipped with an emergency remote board, placed at the back of it, which allows basic management of the functions in the event the handheld device is faulty or not working properly.

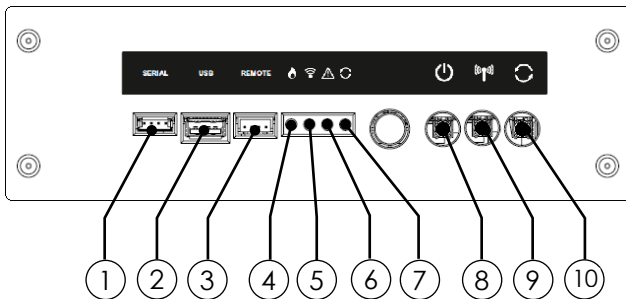

- 1 Serial connection (use by authorised staff ONLY)
- 2 USB connection (use by authorised staff ONLY)
- 3 Emergency cable connection
- 4 GREEN LED - appliance working status
- 5 YELLOW LED - remote communication in progress
- 6 RED LED - alarm on
- 7 BLUE LED - System updating in progress
- 8 Appliance switch on/off button
- 9 Receiver handheld device remote combination button
- 10 Manual upgrade button (use by authorised staff ONLY)

i In the event of malfunctioning of the remote communication between the handheld device and the receiver, or if the batteries are flat, use the **emergency cable** supplied, to restore communication between the remote devices.

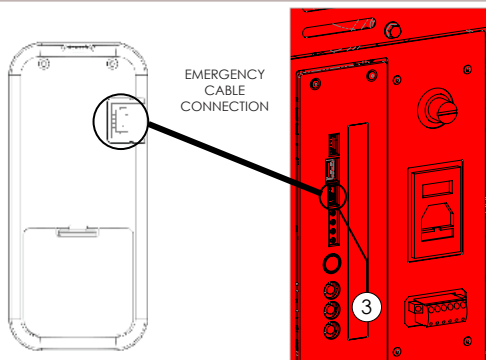

! Before connection using the emergency cable, remove the batteries from the handheld device from the specific compartment. **DANGER OF FIRE**

7.2 KEYS

The handheld device is presented as in the image below:

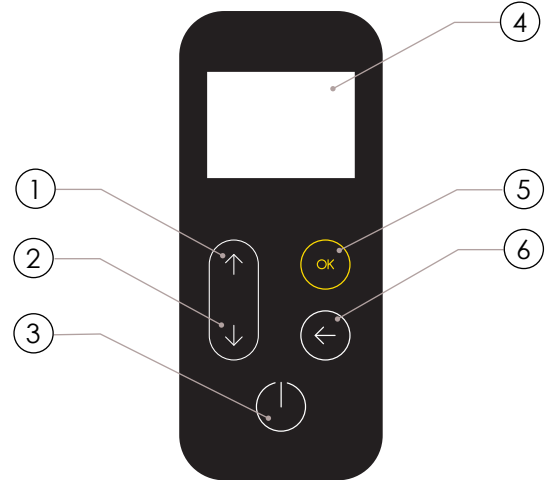

- 1 Increase key (selection key)
- 2 Decrease key (selection key)
- 3 ON/OFF or reset from "Sleep" mode key
- 4 Display
- 5 MENU access and confirm key
- 6 Back to previous screen key

i In "Sleep" mode, the screen of the handheld device is blacked out, only maintaining enabled, if necessary, the remote communication with the appliance, to reduce battery consumption.

7.3 DISPLAY

The handheld device display is as follows:

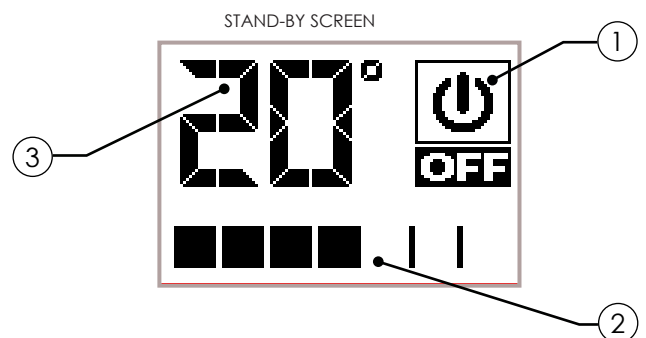

i After 20 seconds of inactivity, the display on the handheld device blacks out and passes to "SLEEP" mode, maintaining the remote connection with the appliance. The display re-enables only by pressing the **⏻** key.

- ① Icon indicating the status of the appliance (see "Concise icons diagram").
- ② Indicates the work power set. Furthermore, by pressing the scroll key (↓), it allows the power setting to be displayed, which can be edited using the two scroll keys (↑)(↓). Confirmation of each variation takes place automatically within 3 seconds of editing the data, or by pressing the confirm (OK) key. An acoustic signal confirms the change was made.



- ③ Displays the ambient temperature detected by the handheld device. Furthermore, pressing the scroll key (↑) allows display of the temperature setting, which can be edited using the two scroll keys (↓)(↑). Confirmation of each variation takes place automatically within 3 seconds of editing the data, or by pressing the confirm key (OK). An acoustic signal confirms the change was made.



7.4 FLAT BATTERIES

If batteries are flat, the display presents a symbol which indicates their limit status, however maintaining the functions enabled of the handheld device.

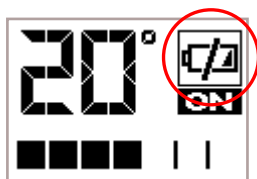

As soon as the level of the batteries does not allow any remote communication, the handheld device displays, on the full screen, the image of the flat battery, blocking all the functions connected to it until the batteries are replaced.



7.5 ICON LIST

①	②	③	MEANING
			SWITCH-ON
			OPERATION
			OPERATION WITHOUT TEMPERATURE CONTROL
			SAVING MODE
			AUTO (see specific paragraph)
			POWERFUL MODE (see specific paragraph)
			OPTIMIZED OPERATION (see specific paragraph)
			BRAZIER CLEANING (where present)
			CLEANER ON (cleaning cycle to empty brazier)
			COMFORT CLIMA ON
			RESTART FROM COMFORT CLIMA
			FINAL CLEANING
			OFF
			WARNING SIGNAL (see specific paragraph)
			FLAME TEMPERATURE OVER LIMIT
			EXCESSIVE PELLET LOADING
			PRESSURE SENSOR FAULT
			FLAME PROBE FAULTY
			REMOTE BATTERIES ALMOST FLAT
			MAX. LIMIT OF SERVICE HOURS REACHED

8 MENU BROWSING

To access the menu, press the key **OK** on the stand-by screen to display the selection items, as in the figure.

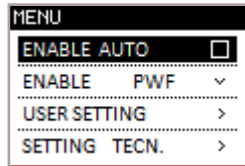

Scroll the menu items using the keys **↑** **↓**

Confirm the selection with the key **OK**

To return to the previous item, key **←**

A practical example follows of how to execute navigation using all the selection keys.

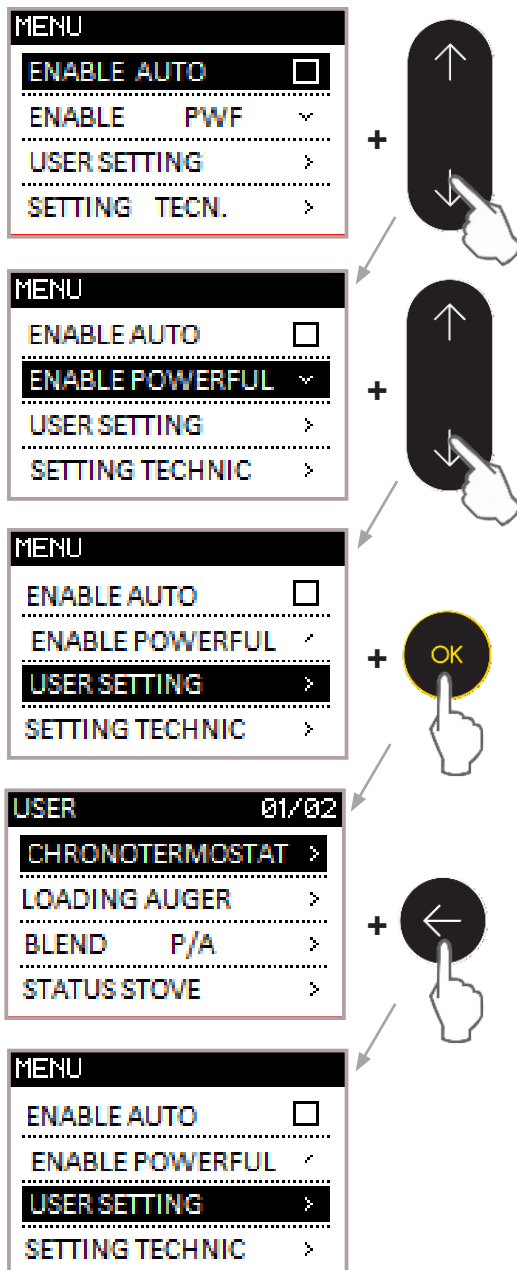

9 FIRST START-UP INSTRUCTIONS

This chapter highlights a series of operations to carry out during the first start-up phase of the appliance.

9.1 DATE AND TIME SETTING

The procedure follows to set the date and time, useful for the thermostat with timer function, on the models of the manufacturer's range.

OPERATING PROCEDURE:

MENU >> USER SETTINGS >> SETTINGS >> TIME - DATE

Access the menu by pressing key **OK**

Scroll the items to SET USER with the key **↓**

Access the menu by pressing key **OK**

Scroll the items to SETTINGS with the key **↓**

Access the menu by pressing key **OK**

Scroll the items to TIME-DATE with the key **↓**

On the TIME - DATE menu item, key **OK**

The screen appears to adjust the time and calendar as in the figure below.

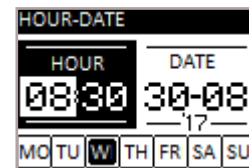

Edit the data highlighted using the keys **↑** **↓**

Confirm the data changed using the key **OK**

Repeat the operation to complete the settings.

During editing, remember that:

- to return to the previous data, without saving the last data changed, press the key **←**
- if you intend changing a single datum, having terminated the change, press the key **OK** multiple times until you exit the function described in the paragraph.

Press **←** multiple times to return to the STAND-BY screen.

9.2 CALIBRATION OF ROOM TEMP. PROBE (REMOTE.)

The procedure follows to calibrate the handheld device probe, if the value should differ from reading a reference sample thermostat.

OPERATING PROCEDURE:

MENU >> USER SETTINGS>> SETTINGS >> CAL. AMB.P.

Access the menu by pressing key **OK**

Scroll the items to SET USER with the key **↓**

Access the menu by pressing key **OK**

Scroll the items to SETTINGS with the key 

Access the menu by pressing key 

Scroll the items to CAL. ROOM PROBE, key 

On the CAL. ROOM PROBE menu item, key 

The screen appears to adjust the ambient probe, as in the figure below.

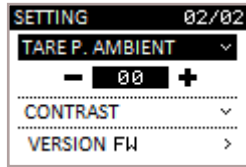

Edit the data highlighted using the keys  

Example: Reference thermostat displays 21°C and handheld device displays 19°C. Set +2 for the handheld device to display the value 21°C.

Confirm the data changed using the key 

To return to the STAND-BY screen, use the key , repeating the operation multiple times.

9.3 USER/AUTO MANAGEMENT

The logic, relating to this type of management, is as follows:

USER: the user reserves the right to



set the ambient temperature he or she wants and the power to the fireplace useful to reach this temperature.

AUTO: the user simply sets





the ambient temperature he or she wants for best comfort, the appliance manages the power to the fireplace and ventilation (if present and enabled) autonomously.

OPERATING PROCEDURE:

MENU >> ENABLE AUTO

Access the menu by pressing key 

The first item on the menu, ENABLE AUTO.

Tick using the key  if you intend managing the appliance in AUTO mode .

Do not tick if you want to work in USER mode .



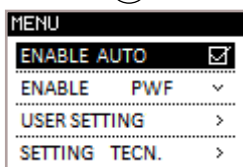



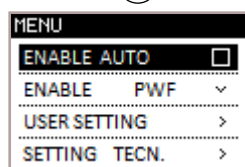

 This setting inhibits manual management of the optional fan, with the exception of the fan setting on OFF. In this case, the appliance autonomously only manages power to the fireplace. Ventilation remains disabled.

9.4 ROOM TEMPERATURE SETTINGS

The ambient temperature defines the temperature you want to obtain in the premises where the product is installed.

From the STAND-BY screen, key  to select the value;

The values vary from 7°C to MAN (with the MAN value it is intended that, once set, the appliance NEVER goes to power save).

Edit the value with the keys  

Confirm the new setting with the key  or wait 3 seconds for auto-confirm.

9.5 FIREPLACE POWER SETTINGS

The fireplace power defines the quantity of heat produced by the appliance, this implies a different fuel consumption. Basically, it is used to speed up the useful time to reach the ideal temperature, set for the premises where the product is installed.

From the STAND-BY screen, key  to select the power;

The values vary from 1 to 7;

Edit the value with the keys  

Confirm the new setting with the key  or wait 3 seconds for auto-confirm.

9.6 SWITCHING ON/OFF THE PRODUCT

To switch on the product, prolonged press the key  until the following screen appears, followed by an acoustic signal.



This screen remains on for the following machine statuses;

- SWITCH ON**
 - WAITING FLAME**
 - FLAME PHASE**
- Initial phase of pellet loading;
 - Flame development waiting phase;
 - Stabilisation phase of flame and oxidiser inside the brazier;

The appearance is highlighted of the "flame" symbol with the writing ON, without displaying the work power.

Long press  to switch off the product and reset any alarms. The operation is accompanied by an acoustic signal.



 For models with an automatic cleaner, during the switch on phase, the product activates a brazier cleaning phase before passing to SWITCH ON. In the event of FAILED IGNITION, after pressing the button, a POP UP signals the need to suck the pellet from the brazier before turning the appliance back on, thus avoiding discharge of unburned pellets into the ash drawer.

 Always vacuum the brazier using an ash cleaner, **FIRE HAZARD.**

 During first start-up of the product, unpleasant odours may occur or smoke caused by evaporation or drying of certain materials used. This phenomena disappears after some hours of use. During this period, you are advised to keep the premises well ventilated.

10 OPERATION

The products in the range include a working phase with 7 operating power levels. The behaviour of the appliance is described below once the setting, if set, is reached of the ambient temperature.

10.1 SAVING MODE

During the work phase, the appliance works with the objective of reaching the ambient temperature set; when this condition is met, power is reduced to SAVING mode, the phase in which fuel consumption is minimal.

At this point, you must execute a series of precisions to benefit the AUTO function, to pass to saving and/or return to fully operational mode:

- Ventilation, if present and enabled, works in different operational modes based on the existing discrepancy between the setting and the temperature in the premises.
- The appliance gradually increases the power to the fireplace, as soon as the temperature in the premises goes under the required setting (optimisation of combustion and acoustic comfort).

Screen in SAVING mode:



10.2 COMFORT CLIMA

As described in the "saving mode" paragraph, the appliance has the objective of meeting the comfortable heating requirements of the user. The function which can be enabled, linked to his mode, also ensures, if the home has a good energy class, a fuel saving through intelligent switch off of the product (reaching or required of the desired setting). The procedure follows to enable the function, the change of values with relevant meaning, a practical example of setting.

OPERATING PROCEDURE:

MENU >> USER SETTINGS >> COMFORT CLIMA

Access the menu by pressing key 

Scroll the items to USER SETTINGS with the key 

Access the menu by pressing key 

Scroll the items to COMFORT CLIMA, key 

On the COMFORT CLIMA menu item, key 

The screen appears with activation of the function and adjustment of the setting parameters, as in the figure.

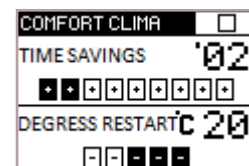

Enable/disable the function with the key  to display the addition or bypassing of the tick and:

- Return to SETUSER with the key .

OR

- Pass, using the key , to the choice of time in saving mode, before the function switches off the product.

Edit the value with the keys  

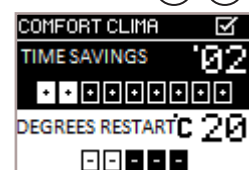

Confirm the data with the key  and go to temperature setting, under which the product must switch on.

Edit the value with the keys



Confirm the data changed using the key **OK** and return to the USER SETTINGS screen.

In saving mode, when changing the time and restart degrees, remember that:

- to return to the previous data, without saving the last data changed, press the key **←**
- if you intend changing a single datum, having terminated the change, press the key **OK** multiple times until you exit the function described in the paragraph.

To return to the STAND-BY screen, use the key **←**, repeating the operation multiple times. STATUS SCREEN.

To recognise switch off of the appliance in COMFORT CLIMA condition, the screen **1** be displayed.

To recognise the appliance is about to switch on in the COMFORT CLIMA condition, the screen **2** must be displayed.

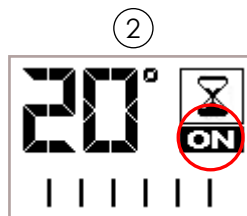
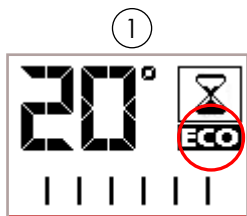

PRACTICAL EXAMPLE:

Ambient setting at 21°C;

Saving mode setting at 3 minutes;

Restart °C setting at -2°C compared to settings.

The appliance switches off as soon as the temperature in the home reaches the value set + 3 minutes in saving mode.

The product switches on when a temperature is detected of 18°C (21°C - 2°C - 0.5°C tolerance).

You can also activate the function using an external thermostat, taking into consideration that this does not include the hysteresis values.

i You are advised to use an external thermostat with its hysteresis value settable up to a maximum of 3°C. Operation of the appliance could start the switch on and off phase many times during the day; this could compromise the duration of switch on resistance.

10.3 POWERFUL FUNCTION

The function described in the paragraph, once activated, allows heating of the ambient, taking advantage of the maximum speed of the fan.

The scope is to supply the maximum heat to the detriment of a minor acoustic comfort.

In this respect, the possibility exists of adjusting the time slot for operation of the POWERFUL function.

i With the POWERFUL function enabled and ventilation disabled (for models that include the optional ventilation), the fan activates autonomously at maximum speed for the activity time of the function.

The logic, relating to this type of management, is as follows:

USER: the user reserves the right to

20° ON set the ambient temperature he or she wants and the power to the fireplace useful to reach this temperature.

POWERFUL: the end user manually activates the function or using the settable

20° ON POWERFUL time slot. The appliance is released from the power set, also forcing ventilation at the maximum speed, for 5 minutes or up to when the setting is reached, or if the time slot or the user disables the function.

OPERATING PROCEDURE 1:

MENU >> ENABLE POWERFUL

Access the menu by pressing key **OK**

Scroll the items to ENABLE POWERFUL, key **↓**

Pressing the key **OK**, the POWERFUL screen appears with the type of setting you want to activate.

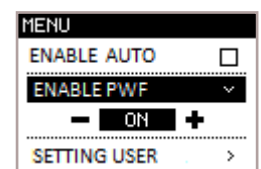
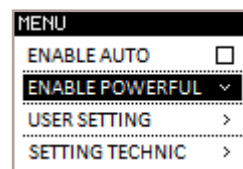

Edit the type of activation with the keys **↑** **↓**

OFF - Powerful disabled;

ON - Powerful enabled;

TIMER - Powerful enabled with time slot.

As previously described, you can set a time slot to enable the function. Below, the operating procedure is displayed to access and edit the data.

OPERATING PROCEDURE 2:

MENU >> USER SETTINGS >> SETTINGS >> POWERFUL

Access the menu by pressing key **OK**

Scroll the items to SET USER, key **↓**

Access the menu by pressing key **OK**

Scroll the items to SETTINGS with the key **↓**

Access the menu by pressing key **OK**

Scroll the items to POWERFUL with the key **↓**

On the POWERFUL menu item, key **OK**

The screen appears with adjustment of the setting parameters, as in the figure below.

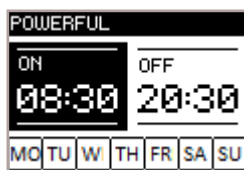

Edit the switch on and switch off times, as well as enabling the days of the week, keys **↑** **↓**

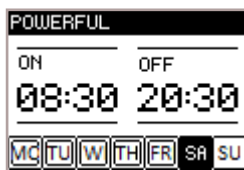

Confirm each data change using the key **OK** until you exit the SETTINGS screen.

During editing, remember that:

- to return to the previous data, without saving the last data changed, press the key **←**
- if you intend changing a single datum, having terminated the change, press the key **OK** multiple times until you exit the function described in the paragraph.

To return to the STAND-BY screen, use the key **←**, repeating the operation multiple times.

i If the time slot is set with the POWERFUL function, the data setting in "Enable Powerful" must be "TIMER". If the value is set to "ON", the time slot is inhibited up to its disabling (OFF).

i The POWERFUL function, if both the time slot and the manual tick are enabled, inhibits AUTO management up to its disabling.

10.4 VENTILATION MANAGEMENT (if optional)

The products of the range with optional ventilation, taking advantage of the natural convection system which guarantees a considerable amount of heat in the ambient, in total absence of noise. However, the possibility exists, by accessing the menu outlined below, to enable optional ventilation according to the desired power.

OPERATING PROCEDURE:

MENU >> USER SETTINGS >> VENTILATION

Access the menu by pressing key **OK**

Scroll the items to USER SETTINGS with the key **↓**

Access the menu by pressing key **OK**

First item in the "VENTILATION" menu, key **OK**

The screen appears with adjustment of ventilation as in the figure below.

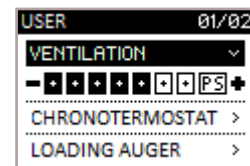

Edit the ventilation power, keys **↑** **↓**

0 - ventilation disabled;
1-7 - ventilation setting range;
PS - ventilation follows power to the fireplace set on the appliance.

i If the PS function is not set, the fan is always restricted by the power of the product.

Confirm with key **OK**

To return to the STAND-BY screen, use the key **←**, repeating the operation multiple times.

11 DESCRIPTION OF THE MENU FUNCTIONS

This chapter describes the functions of the user menu, useful to improve some comfort-related aspects of the user and/or operation of the product.

11.1 PROGRAMMABLE THERMOSTAT

With the Thermostat with timer function, you can: program for each day of the week automatic switch on and off of the product, with 4 independent time intervals (PROGRAM 1 - 2 - 3 - 4).

The steps are outlined below to follow, starting with the STAND-BY screen, to access the relevant menu.

OPERATING PROCEDURE:

MENU >> USER SETTINGS >> THERMOSTAT TIMER

Access the menu by pressing key **OK**

Scroll the items to USER SETTINGS, key **↓**

Access the menu by pressing key **OK**

Scroll the items to THERMOSTAT TIMER, key **↓**

Access the function with the key **OK**

The screen appears with activation of the function and the possibility of selecting 4 TIMED setting programs, as in the figure.

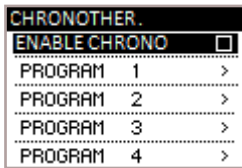

Enable/disable the function with the key **OK** to display the addition or bypassing of the tick and:

- Return to USER SETTINGS with the key **←**.

OR

- Pass, using the key **↓**, to the choice of program to set, before accessing with the key **OK** to change it.

If you want to access 1 of the 4 programs, the screen presented is as follows:

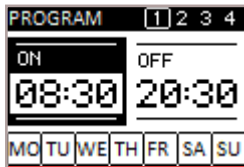

Edit the switch on and switch off times, as well as enabling the days of the week, keys **↑** **↓**
Confirm each data change using the key **OK** and pass to the second screen of the TIMER program.

The screen, in the figure below, displays the possibility of setting the power to the fireplace during activation of the time slot and the temperature you want to obtain in the ambient **①**.
Furthermore, you can manage the ventilation speed (if optional) you want to have at a given power **②**.



Edit the values using the keys **↑** **↓**

Confirm each data change using the key **OK** until you exit the program.

During editing, remember that:

- to return to the previous data, without saving the last data changed, press the key **←**
- if you intend changing a single datum, having terminated the change, press the key **OK** multiple times until you exit the following function.

To return to the STAND-BY screen, use the key **←**, repeating the operation multiple times.

11.2 AUGER LOADING FUNCTION

The following function is necessary to facilitate the switch on phase of the appliance, after accurate cleaning was conducted of the hopper (pellet container) to remove sawdust which, over time, is created on the base. See the chapter "Routine maintenance of the product".

Also check you have placed pellets in the tank and that the appliance is in the "OFF" or "FINAL CLEANING" status before starting the function.

The number expressed in seconds indicates the rotation time of the auger during the loading phase. After this time is up, the auger stops automatically, after which the appliance can switch on.

OPERATING PROCEDURE:

MENU >> USER SETTINGS >> AUGER LOADING

Access the menu by pressing key **OK**

Scroll the items to USER SETTINGS with the key **↓**

Access the menu by pressing key **OK**

Scroll the items to AUGER LOADING, key **OK**

Access the function by pressing key **OK**

The cleaner activates (for models with automatic cleaning), after which pellet loading is enabled. The display shows the time that passes up to 0, corresponding to loading switch off.

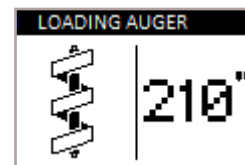

The appliance, at the end of loading, goes to the USER SETTINGS screen.

i After the initial loading phase, a appears POPUP which indicates to suck the pellet from the brazier. This operation does not allow emptying the pellets in the ash drawer when the plate is rotated during ignition.

! Always vacuum the brazier using an ash cleaner, **FIRE HAZARD.**

11.3 PELLET/ASPIRATION RATIO

The PELLET-ASPIRATION ratio setting allows you to change, with immediate effect, the quantity of pellets loaded in the brazier and the quantity of air inbound of the product, tested and inspected with DIN PLUS certified pellets. If you use other pellets or uncertified pellets, combustion may need to be adjusted. Normally, the change is executed on the ASPIRATION percentage to improve combustion; if oxygen adjustment is not efficient, you may need to also change the percentage of PELLETS falling.

OPERATING PROCEDURE:

MENU >> USER SETTINGS >> P/A RATIO

Access the menu by pressing key

Scroll the items to SET USER, key

Access the menu by pressing key

Scroll the items to P/A RATIO with the key

Access the function by pressing key

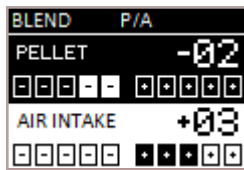

Edit the pellet setting with the keys

The values vary from -5: reduction in pellet load in %
to +5: increase in pellet load in %

Confirm by pressing the key and pass to edit extraction.

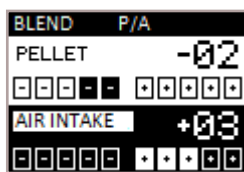

Edit the extraction setting, keys

The values vary from -5: reduction in aspiration in %
to +5: increase in aspiration in %

Confirm by pressing the key and exit adjustment to return to the USER SETTINGS screen.

As for example outlined above, a percentage of -2 PELLET and +3 EXTRACTION was set; this kind of setting results from the fact combustion is lacking oxygen and the pellets are small in size compared to the average 2cm.

During editing, remember that:

- to return to the previous data, without saving the last data changed, press the key
- if you intend changing a single datum, having terminated the change, press the key multiple times until you exit the function described in the paragraph.

To return to the STAND-BY screen, use the key , repeating the operation multiple times.

The number indicated, for setting change, refers to a percentage change which acts on the default parameters set on the electronic board, this only affects the work phase. These values should be changed in the event of poor combustion, due in many cases to use of pellets different from those used for testing the appliance.

11.4 STOVE STATUS

This function allows you to check the most important parameters are working properly on the appliance. Two screens are outlined below which show the list of real data of the product, useful for the support service during the control phases.

OPERATING PROCEDURE:

MENU >> USER SETTINGS >> STOVE STATUS

Access the menu by pressing key

Scroll the items to USER SETTINGS with the key

Access the menu by pressing key

Scroll the items to STOVE STATUS with the key

Access the function by pressing key

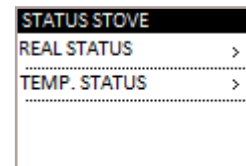

Select the type of screen you want to display, with the keys

Access the relevant screen with the key

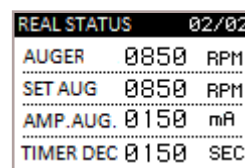
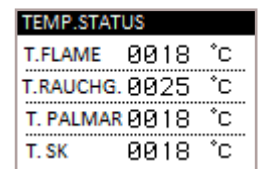
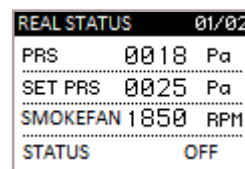

To return to the USER SETTINGS screen,
press the key 

To return to the STAND-BY screen, use the
key , repeating the operation multiple times.

11.5 ENABLE EXTERNAL THERMOSTAT

The following paragraph specifies how to enable the function that includes use of the external thermostat instead of the handheld device, to manage room temperature. Re-connecting to the paragraph called "CONFIGURATION OF T.EXT THERMOSTAT", the procedure is illustrated below for reading the device by the electronic board.

OPERATING PROCEDURE:

MENU >> USER SETTINGS >> SETTINGS >> ENABLE T.EXT

Access the menu by pressing key 



Scroll the items to USER SETTINGS with the 

Access the menu by pressing key 

Scroll the items to SETTINGS with the key 

Access the menu by pressing key 

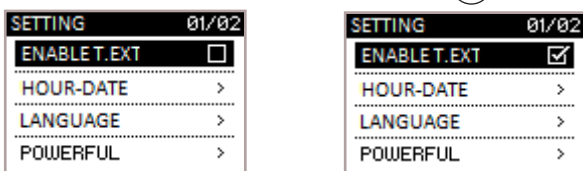

The first item on the menu, ENABLE T.EXT.

Tick using the key  if you want to manage the ambient temperature with the external thermostat (not supplied) .



To return to the STAND-BY screen, use the
key  repeating the operation multiple times.

The STAND-BY, instead of the ambient temperature detected and settable, displays:

- string T ON if the room in which the thermostat is installed has not yet reached the temperature required; 
- the writing T OFF if in the room the ambient temperature is reached. 

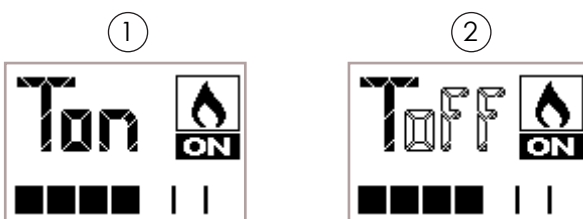

11.6 LANGUAGE

Based on the destination country or the user acquiring the product, this function includes a series of languages to set. The procedure follows to choose the desired language.

OPERATING PROCEDURE:

MENU >> USER SETTINGS >> SETTINGS >> LANGUAGE

Access the menu by pressing key 

Scroll the items to USER SETTINGS with the 

Access the menu by pressing key 

Scroll the items to SETTINGS with the key 

Access the menu by pressing key 

Scroll the items to LANGUAGE with the key 

Access the function by pressing key 



Select the language by pressing the keys  

Confirm the language with the key  and display the tick sign.

To return to the STAND-BY screen, use the
key , repeating the operation multiple times.

11.7 CONTRAST

The procedure follows to improve screen display if the graphic does not show the proposed information clearly.

OPERATING PROCEDURE:

MENU >> USER SETTINGS >> SETTINGS >> CONTRAST

Access the menu by pressing key 

Scroll the items to USER SETTINGS with the key 

Access the menu by pressing key 

Scroll the items to SETTINGS with the key 

Access the menu by pressing key 

Scroll the items to CONTRAST, key 

On the function item, press with key 

The screen appears to adjust contrast relating to the handheld device graphic, as in the figure.

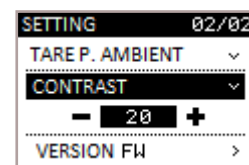

Edit the data highlighted using the keys  

Confirm the data changed using the key 

To return to the STAND-BY screen, use the key , repeating the operation multiple times.

11.8 FIRMWARE VERSION

To view the version of the firmware installed for the appliance model supplied, follow the procedure in this paragraph. This function is useful for the support centre to control availability of the new updates to install on the product, if necessary.

OPERATING PROCEDURE:

`MENU >> USER SETTINGS >> SETTINGS >> FW VERSION`

Access the menu by pressing key 

Scroll the items to USER SETTINGS with the key 

Access the menu by pressing key 

Scroll the items to SETTINGS with the key 

Access the menu by pressing key 

Scroll the items to FIRMWARE VERSION with the key 

Access the function by pressing key 

```

VERSIONE FW
Elemento_aria001
A1U9kW
T033.NBS.AIR.MB01
R026.NBS.AIR.U101
  
```

To return to the STAND-BY screen, use the key , repeating the operation multiple times.

11.9 ANTICONDENSATION (exhaust fumes temperature)

This function ensures that the temperature of exhaust gases remains higher than condensing temperature.

 The function results in a slight increase of pellet consumption to remedy this condition. The causes of condensation can be related to the installation but above all to the yield of the pellets and its size.

OPERATING PROCEDURE::

`MENU' >> USER SETTINGS >> SETTINGS >> ANTICONDENSATION`

Access the menu by pressing key 

Scroll the items to USER SETTINGS with the key 

Access the menu by pressing key 

Scroll the items to SETTINGS with the key 

Access the menu by pressing key 

Scroll the items to ANTICONDENSATION with 

Activate/Deactivate the function by pressing of the key 





To return to the STAND-BY screen, use the key , repeating the operation multiple times.

GENERAL INFORMATION:

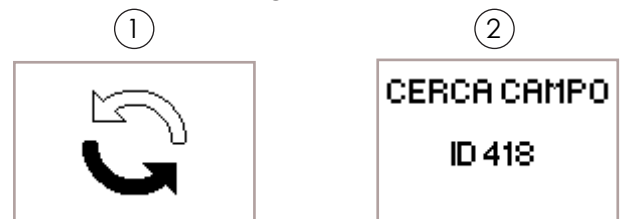
When you browse from one screen to another, you will display the following screen for a few seconds:



This screen indicates the remote control is trying to communicate with the appliance, a useful operation to recover information to display to the end user. 

If communication is absent, the writing FIELD followed by a number appears. In this case, simply approach the appliance to re-establish communication. 

12 CANALIZATION (when applicable)

The products of the range equipped with canalization option can be equipped with single or double canalization. It can be disabled, set manually or managed automatically, depending on the temperature you want to obtain in the room where canalization is installed.

12.1 SINGLE CANALIZATION

In this paragraph, the system is detailed to enable/disable and set in manual the ventilation speed assigned to canalization.

Furthermore, the desired room temperature can be also reached by taking advanced of the automatic management of the stove canalization system.

OPERATING PROCEDURE:

MENU >> USER SETTINGS >> CANALIZATION

Access the menu by pressing key **OK**

Scroll the items to USER SETTINGS with the key **↓**

Access the menu by pressing key **OK**

First item in the "CANALIZATION" menu, key **OK**

The screen appears with setting of channelling, as in the figure.

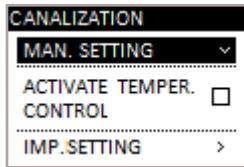

Confirm with key **OK**

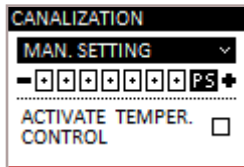

- SET MANUAL: allows you to edit the canalization power, keys: **↑****↓**
 0 - ventilation disabled;
 1-7 - setting range;
 PS - ventilation follows power to the fireplace set on the appliance.

i If the PS function is not set, the fan is always restricted by the power of the product.

- ENABLE TEMPERATURE CONTROL: enables modulation of the ventilation once the set values have been reached;

Enable/disable with the key **OK**

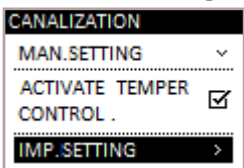

-- MANAGE SETTINGS: allows you to edit the room temperature you want to reach in the room where the canalization system has been installed.

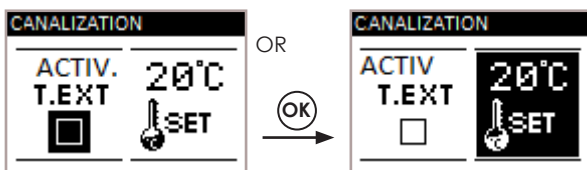

Pressing the keys **↑****↓** to enable/disable the flag if you want to manage the temperature of the zone to channel with the help of the external thermostat. (not supplied). Key **OK** to confirm.

Press the keys **↑****↓** to set the temperature of the zone to channel with the help of an optional ambient probe, provided on request of Nobis s.r.l. (not supplies as standard)

i If the flag is enabled for "channelling" temperature management with the external thermostat, it is not possible to change the temperature setting from the handheld device, but rather from the external thermostat.

12.2 PROGRAMMED CANALIZATION

In the THERMOSTAT TIMER menu, for models with channelling, you can set the channelling power (ventilation speed) and the temperature you want to obtain in the room where the ventilation outlet is installed. Having set all the values relating to programmed switch on of the appliance, the following screen appears.

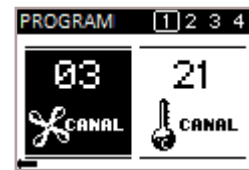

Edit the data highlighted using the keys **↑****↓**

Confirm the data changed using the key **OK**

Repeat the same operation to set the next parameter;

i Setting the ambient temperature for channelling, this is only managed if the TEMPERATURE CONTROL function is enabled, previously seen, ENABLE T.EXT in MANAGE SETTINGS disabled in the CANALIZATION menu.

To return to the STAND-BY screen, use the key **OK**, confirming all the settings.

12.3 DISPLAY CANALIZATION STATUS

To display the channelling status, from the STAND-BY status, press the key **←**. The display screen follows:

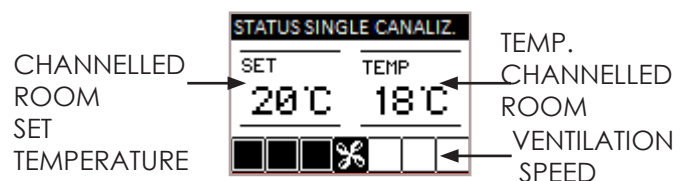

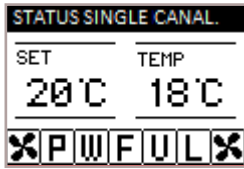

i In the presence of the POWERFUL function, DISPLAY STATUS, you can also see that channelling is in this mode, as in the figure.

i If the PS function is not set, the fan is always restricted by the power of the product.

- ENABLE TEMPERATURE CONTROL: enables modulation of the ventilation/s once the setting has been reached;

Enable/disable with the key **OK**

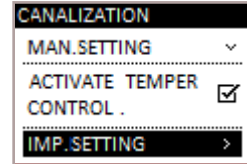

-- MANAGE SETTINGS: allows you to edit the ambient temperature setting you want to reach in the channelled ambient.

12.4 DOUBLE CANALIZATION

In this paragraph, the system is detailed to enable/disable and set in manual the ventilation speed assigned to channelling. Furthermore, the possibility is set to enable the automatic management function of double channelling, linked to setting of the ambient temperature you want to obtain in the rooms.

OPERATING PROCEDURE:

MENU >> USER SETTINGS >> CANALIZATION

- Access the menu by pressing key **OK**
- Scroll the items to USER SETTINGS with the key **↓**
- Access the menu by pressing key **OK**
- First item in the "CANALIZATION" menu, key **OK**
- The screen appears with setting of channelling, as in the figure.

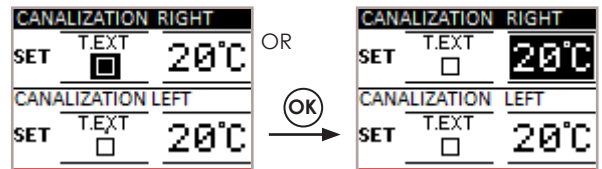

Press the keys **↑****↓** to enable/disable the flag if you want to manage the temperature of the zone to channel with the help of the external thermostat. (not supplied). Key **OK** to confirm.

Press the keys **↑****↓** to set the temperature of the zone to channel with the help of an optional ambient probe, provided on request of Nobis s.r.l. (not supplies as standard)

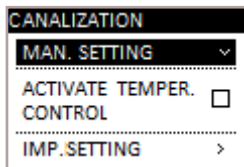

Having confirmed setting of the RH channelling, confirm with the key **OK** and repeat the same sequence of operations for the LH channelling.

Confirm with key **OK**

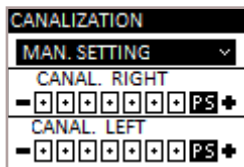

i If the flag is enabled for "channelling" temperature management with the external thermostat, it is not possible to change the temperature setting from the handheld device, but rather from the external thermostat.

- SET MANUAL: allows you to edit the power of channelling, keys: **↑****↓**

- 0 - ventilation disabled;
- 1-7 - setting range;
- PS - ventilation follows power to the fireplace set on the appliance.

Press key **OK** to confirm setting of the RH fan and pass to set the LH.

12.5 PROGRAMMED CANALIZATION

In the THERMOSTAT TIMER menu, for models equipped with canalization system, you can set the canalization power (ventilation speed) and the temperature you want to obtain in the room where the ventilation outlets are installed. Having set all the values relating to programmed switch-on of the appliance, the following screen will appear.

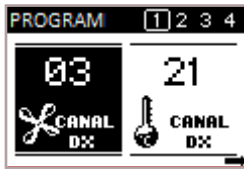

Edit the data highlighted using the keys
 Confirm the data changed using the key
 Repeat the same operation to set the following parameter;

i Room temperature for the canalization system can only be managed if the TEMPERATURE CONTROL function is enabled, as previously seen, and ENABLE T.TEXT in MANAGE SETTINGS disabled in the CANALIZATION menu.

Confirm your settings for the RH channelling, press and repeat the same sequence of operations for the LH channelling.

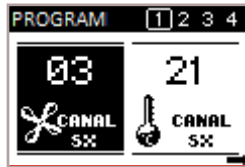

Edit the data highlighted using the keys
 Confirm the data changed using the key
 Repeat the same operation to set the following parameter;
 To return to the STAND-BY screen, use the key , confirming all the settings.

12.6 DISPLAY CANALIZATION STATUS

To display the canalization status, from the STAND-BY status, press the key .
 The display screen follows:

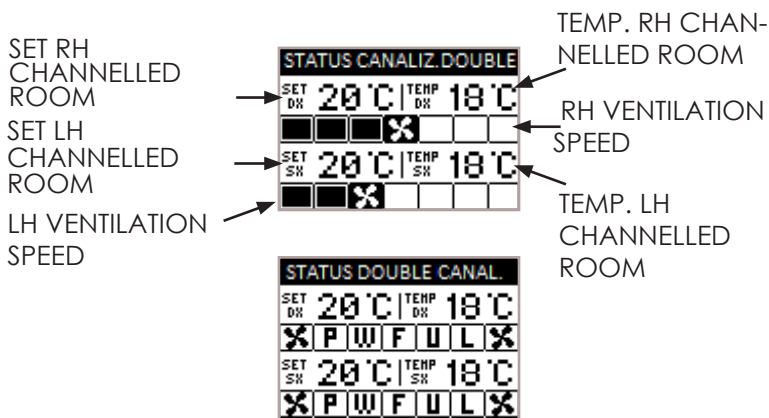





i When the POWERFUL function is enabled, in display status, you can also see that channelling is in this mode, as in the figure below.

13 PHASE LIST



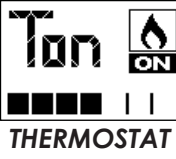

PHASE	DESCRIPTION
 SWITCH ON WAITING FLAME FLAME PHASE	- The phase starts to pre-heat the resistor and the pellet starts to fall in the brazier. - The pellet switches on by taking advantage of the heat in the inlet air which passes by the duct of the incandescent resistor. - Pellet loading restarts and the flame develops.
 WORK	The appliance has terminated the switch on phase and goes to the working power set.
 SAVING	The desired ambient temperature is reached.
 BRAZIER CLEANING	The cleaning phase is enabled of the brazier without movement of the cleaner (periodic function).
 CLEANER ENABLED	The brazier cleaning phase is running with the cleaner enabled. The appliance switches off and switches back on autonomously.
 RESTART	Switch on is required after a cooling phase. Once reached this condition, the appliance restarts automatically.
 FINAL CLEANING	The appliance is in the switch off phase and the cooling phase has not yet terminated.
 OFF	The appliance is OFF and all the motors are disabled.

14 FUNCTION LIST



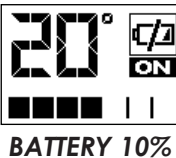
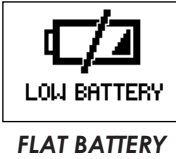

PHASE	DESCRIPTION
 MAN OP.	Room settings is on MAN; therefore the appliance will only work with the fireplace power as per settings (never switching to saving mode)



PHASE	DESCRIPTION
 THERMOSTAT	Management was chosen of the ambient temperature using an external thermostat (not supplied by the manufacturer)
 COMFORT CLIMA	With the COMFORT CLIMA enabled, the product automatically switches off on reaching the ambient setting set (see relative paragraph).
 AUTO	The appliance automatically manages the power to the fireplace and ventilation (where present and enabled) to guarantee better comfort (see specific paragraph).
 POWERFUL	The appliance works with ventilation at the maximum speed to speed up heating of the environment.(see relative paragraph)
 OPTIMAL FLAME	The appliance optimises combustion by reducing the pellet load, however yield is guaranteed.

15 SIGNAL LIST

PHASE	DESCRIPTION
 ALARM	The appliance is in alarm status, consult the "ALARMS" chapter to for further details.
 ANOMALY	The appliance signals an anomaly, without causing it to switch off. See "ANOMALY LIST".
 BATTERY 10%	The remote control batteries are almost flat.
 FLAT BATTERY	The remote batteries are flat. Replace them.
 SERVICE HOURS	The threshold for the working hours set has been reached. It is recommended to have the extraordinary maintenance service carried out by authorised staff.

16 ANOMALY LIST

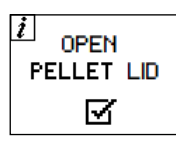
PHASE	DESCRIPTION
 FAULTY PRESS. SENSOR	The appliance signals a malfunction of the sensor controlling correct combustion. For safety purposes, while waiting for the technician, the appliance is set to saving mode.
 HOT SMOKE	The maximum smoke temperature threshold has been reached; the appliance for a period sets to saving mode with ventilation at maximum power to cool the body.
 EXCESS LOAD	If the quantity of pellets is high for the power of the machine. In P/E mix, reduce the pellet load working on the % (see specific paragraph)
 S.FLAME FAULT	The appliance signals a malfunction of the probe detecting the flame. For safety purposes, while waiting for technical intervention, the appliance sets to saving mode.

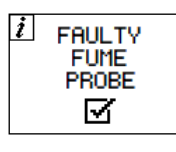
PHASE	DESCRIPTION
 OPEN PELLETT LID	The anomaly is presented when the user opens the door or ash pan or pellet door; at this point, pellet loading inside the brazier stops and the electronics emit an acoustic signal. The user, to return to correct operation, must close the doors. If this operation is not carried out, the product will trigger an alarm.
 DOOR/ASH DRAWER OPEN	
 FAULTY FUME PROBE	

 The anomalies, unlike alarms, are signals which automatically reset once the cause that triggered them has been solved. Furthermore, signalling will not switch off the appliance, and normal operation will not be interrupted.

 Some anomalies need technical intervention by authorised staff to be solved. Despite the appliance continuing to work, the user must ensure the problem gets solved. **Negligence will cause malfunctioning.**

17 DESCRIPTION OF ALARMS



Each alarm condition causes the appliance to immediately switch off. Press the switch on key P3 to reset the alarm. Before switching the appliance back on, make sure the problem has been solved.

ALARM CODE	REASON
01 BLACK OUT	No power during the operation
	SOLUTION
	Press the switch-off key and repeat switch on of the appliance If the problem persists, contact the Support Service.

ALARM CODE	REASON
02 NO SWITCH ON	The pellet tank is empty.
	Calibration of the pellets and suction during the start-up phase inadequate.
	Ignition resistor faulty or out of position
	SOLUTION
	Check there are pellets in the tank. If necessary, load. If the problem persists, contact the Support Service

ALARM CODE	REASON
03 PELLETS FINISHED	The pellet tank is empty.
	The gearmotor is not loading pellets
	Lack of pellets loading
	SOLUTION
	Check there are pellets in the tank. If necessary, load
	Empty the tank to check that there are no objects inside it.
	Adjust, by increasing the load of pellets, from "P/A RATIO" If the problem persists, contact the Support Service

ALARM CODE	REASON
04 SMOKE TEMPERATURE	Combustion in the brazier is not optimal as it is clogged or the inner passages of the appliance are clogged.
	The tangential fan (if present) is not working properly or is damaged.
	SOLUTION
	Switch the product off and back on again, activating the cleaner; adjust the combustion with the "P/A ratio". If the problem persists, contact the Support Service

ALARM CODE	REASON
05 EXTRACTOR ROTATIONS NOT RESPECTED	The rotations of the smoke extractor show a loss of efficiency due to obstruction of the fan or a drop in voltage.
	SOLUTION
	If the problem persists, contact the Support Service

ALARM CODE	REASON
06 FAULTY SMOKE EXTRACTOR	No power supply to the smoke extractor
	The smoke extractor is blocked
	SOLUTION
	If the problem persists, contact the Support Service

ALARM CODE	REASON
07 GEARMOTOR ROTATIONS NOT RESPECTED PELLET LOADING	The rotations of the gearmotor present a loss of efficiency due to a drop in voltage.
	SOLUTION
	If the problem persists, contact the Support Service

ALARM CODE	REASON
08 PELLET LOADING GEARMOTOR FAULT	Gearmotor encoder not working or not connected correctly
	No power to the gearmotor
	SOLUTION
	If the problem persists, contact the Support Service

ALARM CODE	REASON
09 PELLET LOADING AUGER BLOCKED	Possible foreign body or sawdust preventing correct movement.
	SOLUTION
	Empty the tank and check for foreign bodies. If the problem persists, contact the Support Service

ALARM CODE	REASON
10 PELLET LOADING AUGER POWER SUPPLY DEFECT	No power supply or power supplied by electronic control unit not correct
	SOLUTION
	If the problem persists, contact the Support Service

ALARM CODE	REASON
11 MINIMUM PRESSURE PASCAL	The sensor does not detect negative air pressure Inbound of the appliance.
	SOLUTION
	Check the door and ash pan are closed correctly, check if the air intake tube is obstructed. If the problem persists, ccontact the Support Service.

ALARM CODE	REASON
12 BRAZIER CLEANER FAULT	The cleaner has not completed movement and is not found in the correct position or the fire door is not closed correctly.
	SOLUTION
	Check if the door is closed correctly, reset the alarm and wait for the product to go to OFF status. Disconnect and reconnected current, the system re-activates the cleaner, checking the correct position again.
	If the problem persists, contact the Support Service

ALARM CODE	REASON
13 NEGATIVE PRESSURE IN CHIMNEY FLUE	The chimney flue is blocked.
	The sensor reading the negative pressure is not working properly.
	SOLUTION
	Check the chimney flue is not blocked, contact a chimney sweep to clean it.
	If the problem persists, contact the Support Service

ALARM CODE	REASON
14 THERMOSTAT MANUAL RESET	You have to manually reset the thermostat connected to the hopper.
	Combustion in the brazier is not optimal as the brazier is clogged or the inner passages of the appliance are clogged.
	Ventilation, where present and active, may not be working properly.
	SOLUTION
	Reset the thermostat by pressing the button on the back of the appliance.
	Switch off the product, switch on the system again to activate the cleaner and adjust combustion with the P/E mix.
	If the problem persists, contact the Support Service.

MANUAL RESET THERMAL SWITCH POSITION

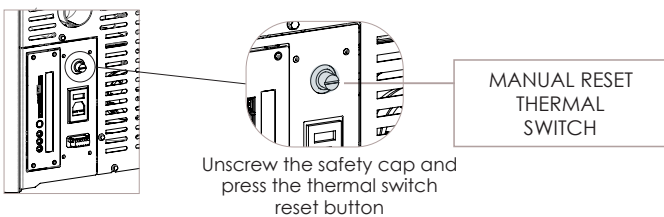

ALARM CODE	REASON
15 FIRE DOOR/ ASH PAN OPEN	During the cleaning phase of the product, the door to the fire or the ash pan was not closed properly.
	SOLUTION
	Check correct closure of the fire door and/or correct insertion of the ash pan in its compartment.
	If the problem persists, contact the Support Service

ALARM CODE	REASON
16 PELLET TANK DOOR OPEN	During the pellet loading phase of the product, the tank door was not closed properly.
	SOLUTION
	Check the pellet tank door is closed properly.
	If the problem persists, contact the Support Service

ALARM CODE	REASON
18 FLAME PROBE	Simultaneous flame probe and smoke probe fault.
	SOLUTION
	Contact Technical Support.

ALARM CODE	REASON
22 FLAME TEMPERATURE	Combustion in the brazier is not optimal as the brazier is clogged or the inner passages of the appliance are clogged.
	The tangential fan (if present) is not working properly or is damaged.
	SOLUTION
	Switch the product off and back on again, activating the cleaner; adjust the combustion with the "P/E mix".
	If the problem persists, contact the Support Service.

ALARM CODE	REASON
23 AUGER TRIAC	Anomaly of an internal component of the electronic board that manages the pellet loading auger.
	Possible drops in voltage or wrong voltage input to the device.
	SOLUTION
	Check power supply voltage.
	If the problem persists, contact the Support Service

ALARM CODE	REASON
24 AUGER PHASE	No connection of cabling that brings power to the auger gearmotor.
	SOLUTION
	If the problem persists, contact the Support Service

ALARM CODE	REASON
28 REVOLUTION FAILURE SMOKE ENCODER	Smoke extractor encoder not working or not connected correctly
	SOLUTION
	If the problem persists, contact the Support Service

ALARM CODE	REASON
29 CLEANING CYCLE LIMIT	The maximum limit of cleaning cycles allowed during a work phase has been reached prolonged.
	SOLUTION
	In safety, vacuum the brazier and switch on again.
	If the problem persists, contact the Support Service

ALARM CODE	REASON
30 BYPASS EMERGENCY HATCH OPEN	La botola di sicurezza si è aperta a seguito blackout.
	SOLUTION
	Once the electrical power is restored, lock the hatch in place using the special knob, pushing it completely downwards. If the problem persists, contact the Support Service.
ALARM CODE	REASON
31 FAULTY PELLET/WOOD-AIR VALVE	The automatic movement system of the valve controlling the pellet/wood ratio is not working correctly.
	SOLUTION
	Reset the alarm. Press the I/O to turn off the stove, wait for 5 seconds, then restart the stove. If the problem persists, contact the Support Service.
ALARM CODE	REASON
32 FAULTY BYPASS EMERGENCY SYSTEM	One of the components of the emergency bypass hatch system is faulty or blocked.
	SOLUTION
	Move the knob to check the correct movement of the lever and that the hatch is kept closed. If the problem persists, contact the Support Service.

18.1 CLEANING THE FIREPLACE

Open the fire door, using the specific tool and:

- vacuum the slide bringing the ash to the brazier;
- dismantle the flame trap, vacuum the compartment hidden by the flame trap (paying utmost attention not to damage the sensor placed behind the flame trap).
- the vermiculite does not require cleaning, in any case if you intend eliminating the soot dust, only use a soft bristle brush.

OPERATING PROCEDURE:

Open the fire door using the "cold lever" supplied with the product and insert the "cold lever" in the specific compartment, as indicated in the figure below:

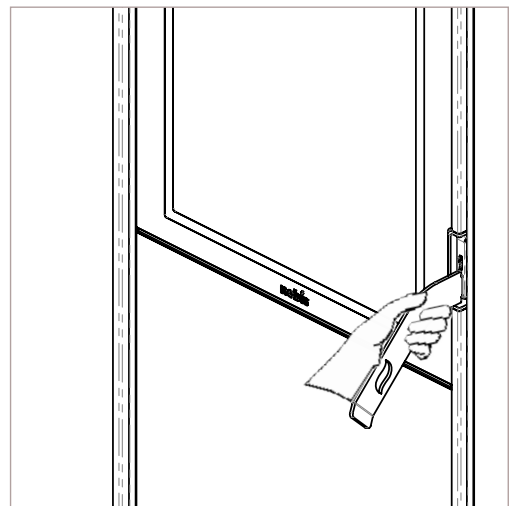
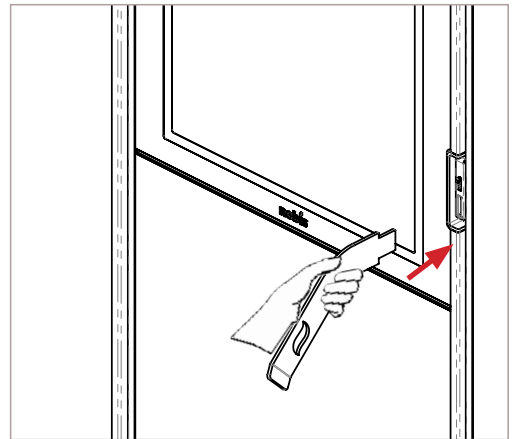

18 CLEANING THE APPLIANCE



Product installation must take place in such a way as to ensure easy access to the appliance itself and to the flue for cleaning and maintenance operations.



Please carefully adhere to the following instructions for correct cleaning of the appliance. Non-compliance could cause its malfunctioning.

Before carrying out any cleaning operation on the appliance, take the following precautions:

- switch off the product and in "OFF" status disconnect the power supply cable;
- ensure all the parts are cold to touch;
- ensure the combustion ash is completely out.

To clean the surfaces, on the painted metal parts, use a cloth soaked in water and soap.

Using abrasive detergents or diluents will damage to the surface of the product.

Lift the "cold lever", supplied with the product, to unlock and open the fire door, as in the figure below:

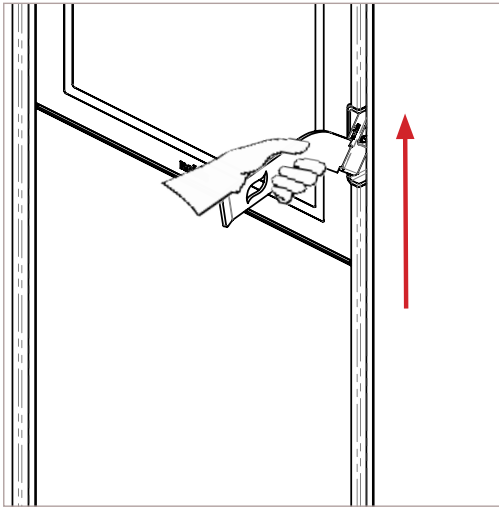

With a soft brush, eliminate the combustion particulate, letting it fall in the ash slide.

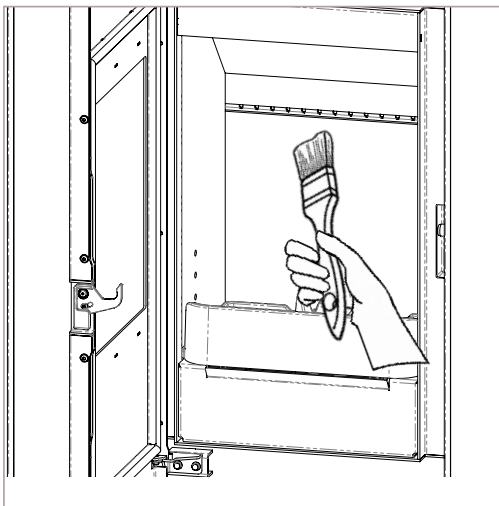

Vacuum the cast-iron combustion plate and the fire pit, paying attention not to knock the nozzle of the vacuum cleaner against the vermiculite.

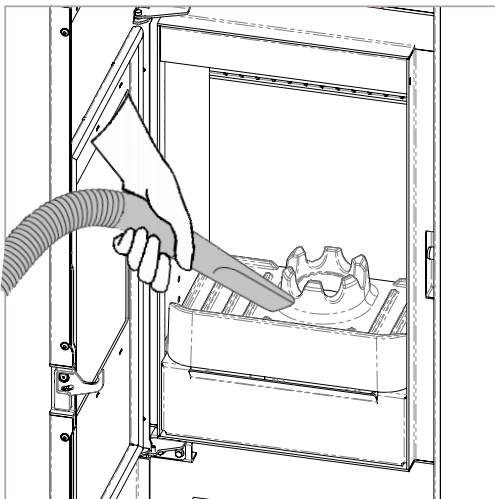

18.2 CLEANING THE GLASS DOOR

To clean the glass, use a cotton cloth or kitchen paper. You are advised to clean the glass using a damp cloth with water and combustion ash (with an abrasive function), avoiding use of products with additives that could, over time, wear the seals, glass and paint.

i Do not switch on the appliance if the glass is damaged. Contact the support service to replace it.

OPERATING PROCEDURE:

Clean with a cotton cloth as in the figure below:

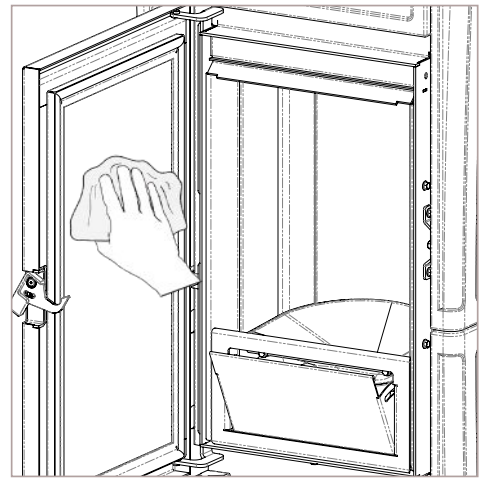

18.3 CLEANING THE ASH PAN

Remove the pan from the appliance and remove the ash deposited, using an ash vacuum cleaner; pay utmost attention to the presence of embers that could still be hot and which could damage the appliance used for cleaning.

i The cleaning operations depend on the quality of the pellets used and the frequency of use of the product. It can happen that such operations must be carried out more frequently than stated in the manual.

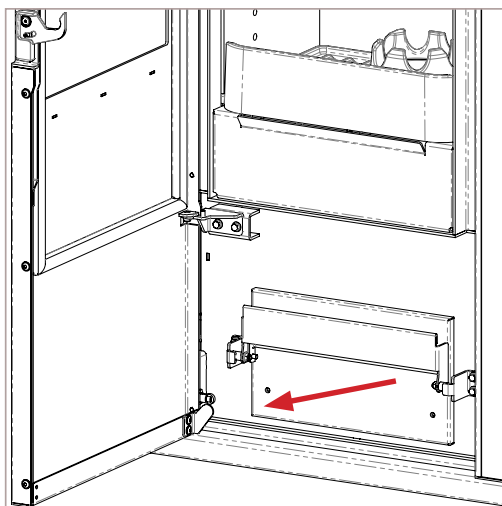

Open the drawer using the handle, as in the figure below:

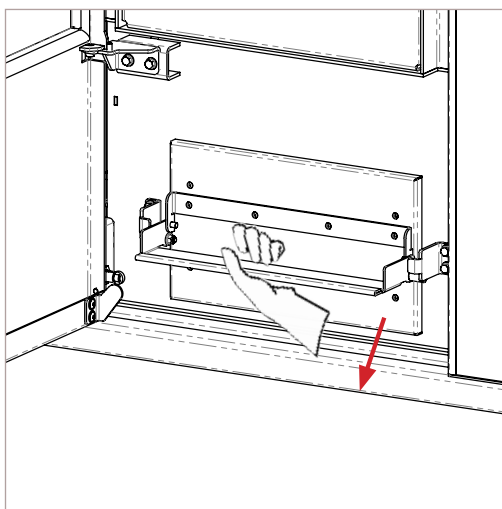

Remove the ash pan and empty it, as in the figure below:

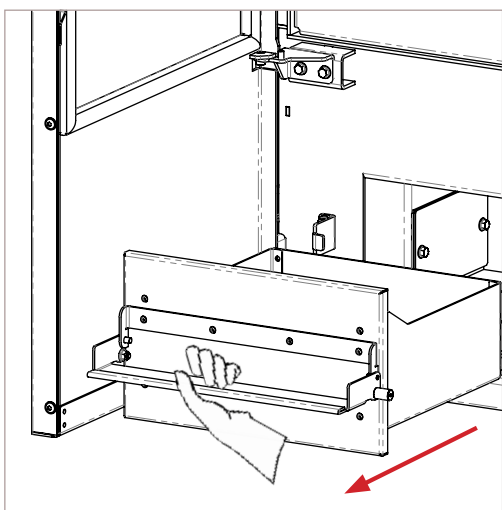

CLEANING CYCLES: TABLE

Essential control and/or maintenance interventions to be carried out for proper functioning of the appliance are summarised in the table below:

PARTS/FREQUENCY	TIME
Ash pan (approx. time)	7 DD
Glass	2-3 DD
Extraction pipe *	1 SE
Door seal/ash pan*	1 SE
Tube bundle scraper (where present)	7 DD
Chimney flue	1 SE
Combustion chamber	2-3 DD
Vacuum pellet tank	30 DD
Electromechanical components*	1 SE

LEGEND:

- * - operations which can be carried out by a technician authorized by the manufacturer;
- DD - day/s
- SE - season

19 WIRING DIAGRAM

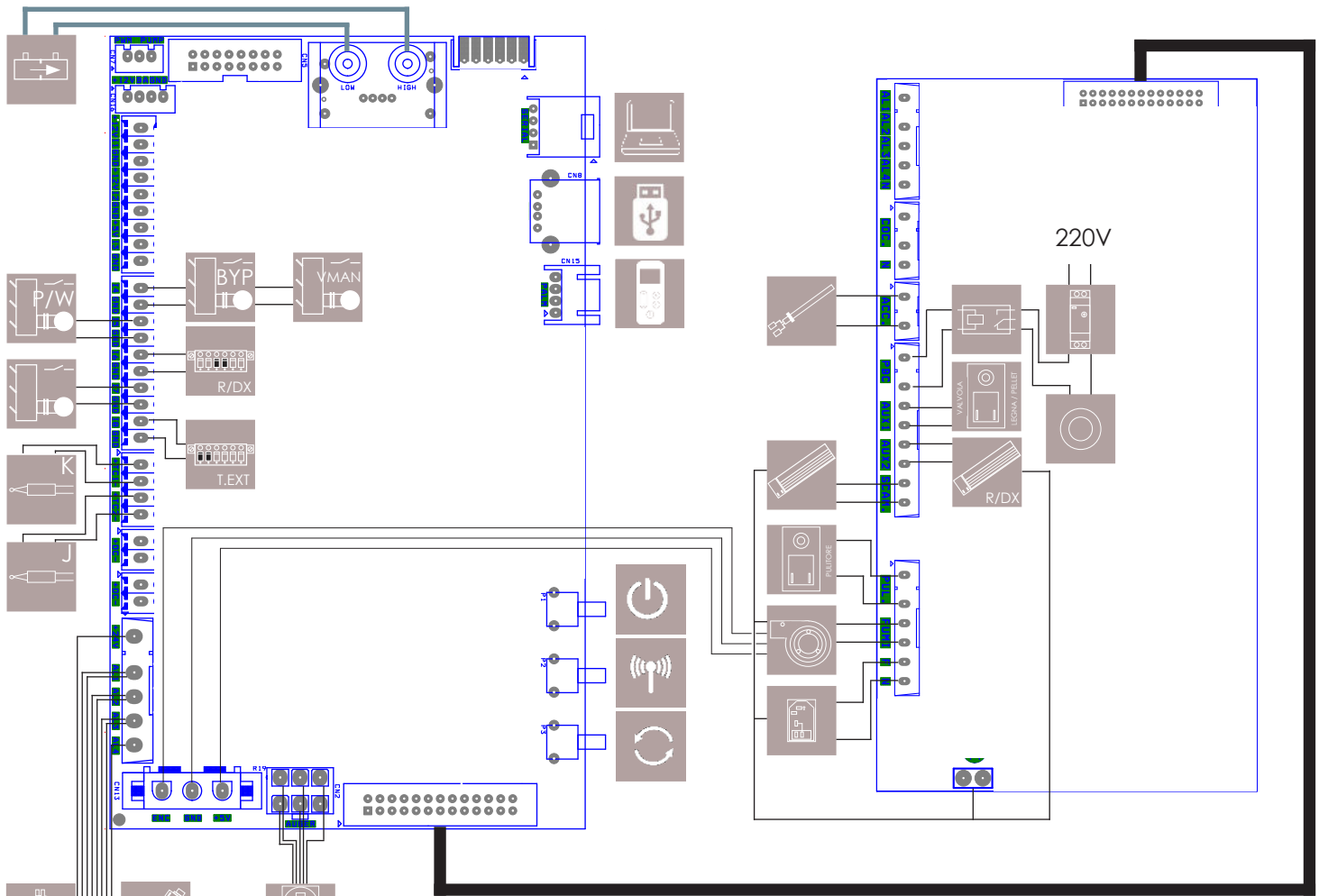

LEGEND:

- | | | | | | | | |
|--|--|--|---|--|--|--|---|
| | PRESSURE SENSOR | | RELAIS 220V | | ELECTROMAGNET | | TRANSFORMER
220V - 24V |
| | STROKE COUNTER
MECHANICAL CLEANER | | SMOKE EXTRACTOR | | SAFETY
VACUUM SWITCH | | REMOTE UNIT SELECTION
KEY |
| | TERMINAL BOARD
CONNECTION
T.EXTERNAL | | MANUAL RESET THERMAL
SWITCH | | FRONT
VENTILATION | | UPGRADE FW KEY
(technical support only) |
| | FLAME PROBE | | RESISTOR
SWITCH ON | | PC CONNECTION
(technical support only) | | VENTILATION
REAR OR RH |
| | SMOKE PROBE | | GEARMOTOR
MECHANICAL CLEANER | | USB CONNECTION
(technical support only) | | TERMINAL BOARD
PROBE OR T.EXT REAR
OR REAR RH |
| | GEARMOTOR
BLDC 24V | | CONTACT DOOR/
ASH PAN (1)
PELLET TANK (2) | | REMOTE CONTROL
EMERGENCY CABLE | | VENTILATION
REAR LH |
| | PELLET/WOOD VALVE
CONTACT | | 220V SOCKET WITH
ON/OFF SWITCH
AND FUSE | | APPLIANCE SWITCH ON
KEY | | WOOD MANUAL VALVE
CONTACT |
| | WOOD BYPASS
CONTACT | | | | | | |



NOBIS Srl

Via Palazzolo, 11
25037 - Pontoglio - BS
www.nobisfire.it

Nobis Srl cannot be held, in any way, liable for any errors in this manual and considers itself free to change the features of its products without prior notice.

Cod. 110-002-0031N_S1